

ST40 Compass Instrument Owner's Handbook

Document number: 81161_2
Date: 1st May 2001

Important information

WARNING

Although your ST40 instrument is designed to give accurate and reliable performance, it should serve only as an aid to navigation and should never lead to the erosion of good seamanship. Always maintain a permanent watch and be aware of situations as they develop.

EMC conformance

All Raymarine equipment and accessories are designed to the best industry standards for use in the leisure marine environment.

The design and manufacture of Raymarine equipment and accessories conform to the appropriate Electromagnetic Compatibility (EMC) standards, but correct installation is required to ensure that performance is not compromised.

Handbook information

To the best of our knowledge, the information in this handbook was correct when it went to press. However, the Raymarine policy of continuous product improvement may change product specifications without notice. Consequently, unavoidable differences may occur between the product and the handbook from time to time, for which Raymarine cannot accept liability.

Contents

- Important information i**
 - WARNING i
 - EMC conformance i
 - Handbook information i

- Preface v**
 - Parts supplied vi

- Chapter 1: Operation 1**
 - 1.1 Introduction 1
 - 1.2 Operating procedures 1
 - Silencing alarms 1
 - Backlighting and contrast adjustment 3
 - Compass heading screen 4
 - Locked heading screen 4
 - 1.4 Alarms 5
 - Off course active alarm 5
 - Enabling/disabling alarm 5
 - Man overboard alarm (repeated) 5

- Chapter 2: Maintenance and Fault Finding 7**
 - 2.1 Maintenance 7
 - Servicing and safety 7
 - Instrument 8
 - Transducer 8
 - Cabling 8
 - 2.2 Fault finding 8
 - Preliminary procedures 8
 - Fixing faults 8
 - Assistance 10

Chapter 3: Installation	11
3.1 Planning your installation	11
EMC installation guidelines	11
Suppression Ferrites	12
Connections to Other Equipment	12
Tools required	12
Site requirements	13
Fluxgate Compass transducer	13
Instrument	14
3.2 Procedures	15
Fitting Fluxgate Compass transducer	15
Introduction	15
Stand alone instrument	15
System requirements	15
Installation	15
Running transducer cable	16
Connections to the instrument	17
Stand-alone connections	18
SeaTalk connections	19
Fitting the instrument	19
Desktop Mounting Bracket	21
3.3 Calibration requirement	22
Chapter 4: Calibration	23
4.1 Introduction	23
EMC conformance	23
4.2 User calibration	23
4.4 Dealer calibration	25
Instrument Specification	27
Glossary	29
Index	31

Preface

Thank you for purchasing a Raymarine product. We are sure your ST40 instrument will give you many years of trouble-free operation.

This instrument is designed to provide reliable performance, even under the most demanding conditions.

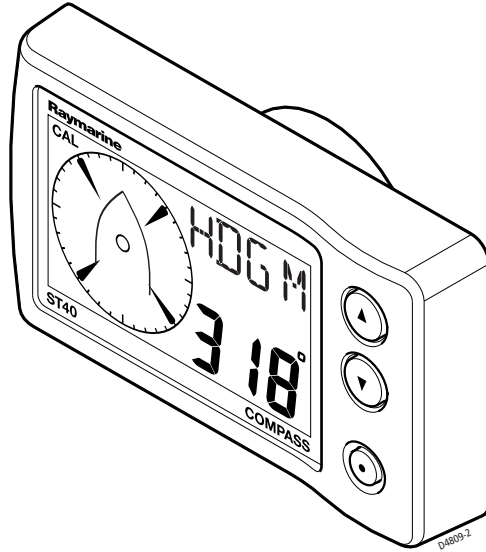

Parts supplied

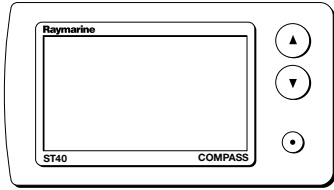

ST40 Compass instrument

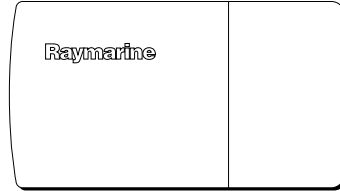

Instrument Cover

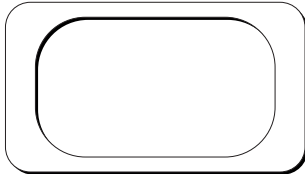

Gasket



1 m (3 ft) power cable

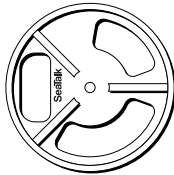

Clamping bracket

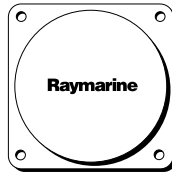

Fluxgate compass transducer

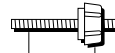

Fixing stud
Thumb nut

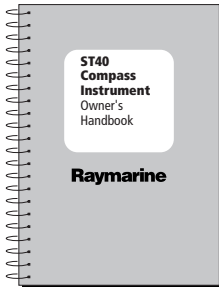

Owner's Handbook.
Warranty document and fitting templates included in Handbook

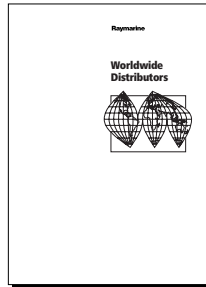

Worldwide Service Centre Handbook.

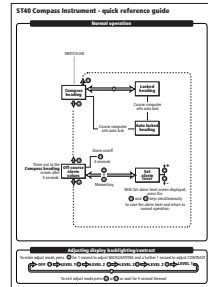

Quick Reference Guide

Note:

The items shown here are supplied for an ST40 Compass system. If an instrument is purchased separately, a transducer is not included. If any item is not present, contact your Raymarine Dealer.

Chapter 1: Operation

1.1 Introduction

Your ST40 Compass instrument:

- Provides true and magnetic bearing information.
- Enables a locked bearing to be defined either manually, or automatically by a course computer. In this mode, the instrument shows the deviations from the locked bearing and the direction to steer to achieve the locked bearing.

CAUTION

Your instrument is calibrated to factory (default) settings when first supplied and must therefore be calibrated before use, to ensure optimum performance on your vessel. Do NOT use the instrument until the calibration procedures have been satisfactorily completed, using the procedures in *Chapter 4, Calibration*.

Coloured bezel and Desktop Mounting Bracket options are available for your ST40 instrument. Contact your Raymarine dealer for further information.

1.2 Operating procedures

Operating information is presented in flow chart form. The flow charts show the various operating screens and key presses necessary to carry out the various instrument functions. Key presses are momentary unless otherwise stated.

Silencing alarms

To silence an alarm (see the *Alarms* section, later in this chapter), momentarily press any one of the instrument keys.

NORMAL OPERATION

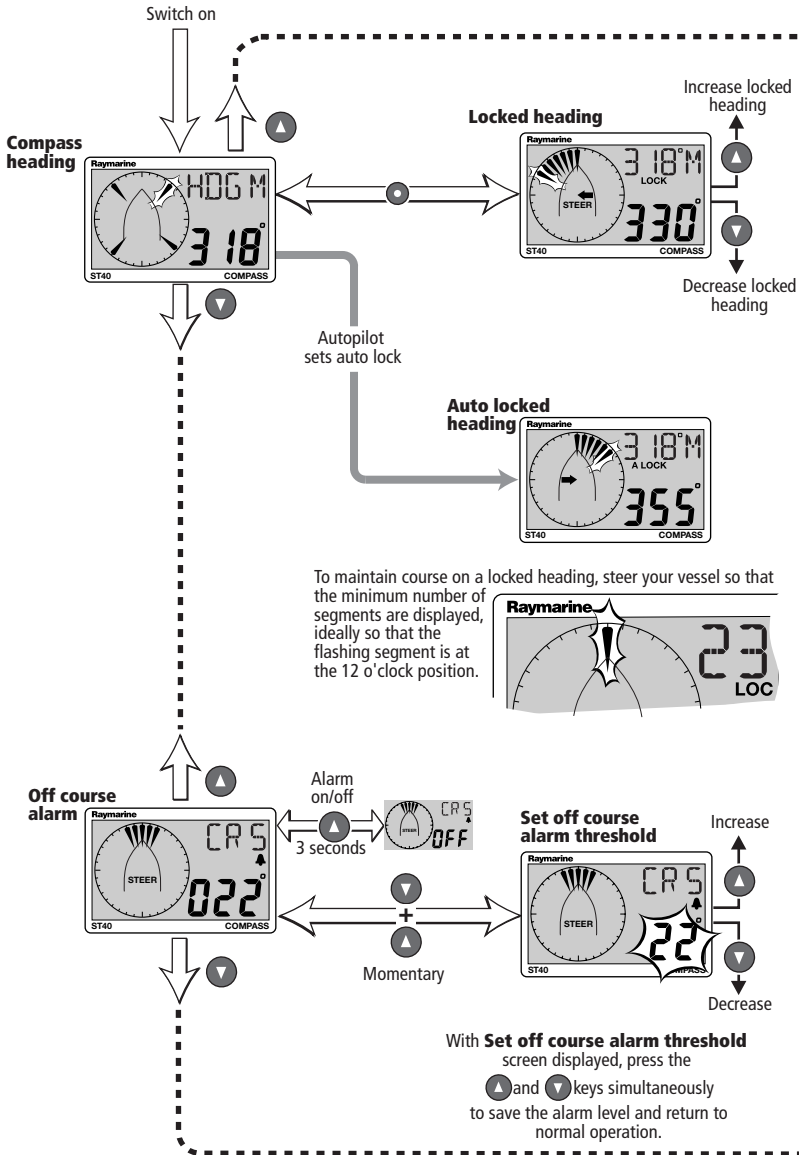

Note:
 The **Off course alarm** screen is temporary and will time-out to the Compass heading screen after 5 seconds.
 Only available on master instruments.

Backlighting and contrast adjustment

Hold down  for 1 second to enter Adjust Backlight mode
for 2 seconds to move through Adjust Backlight mode and enter Adjust Contrast mode

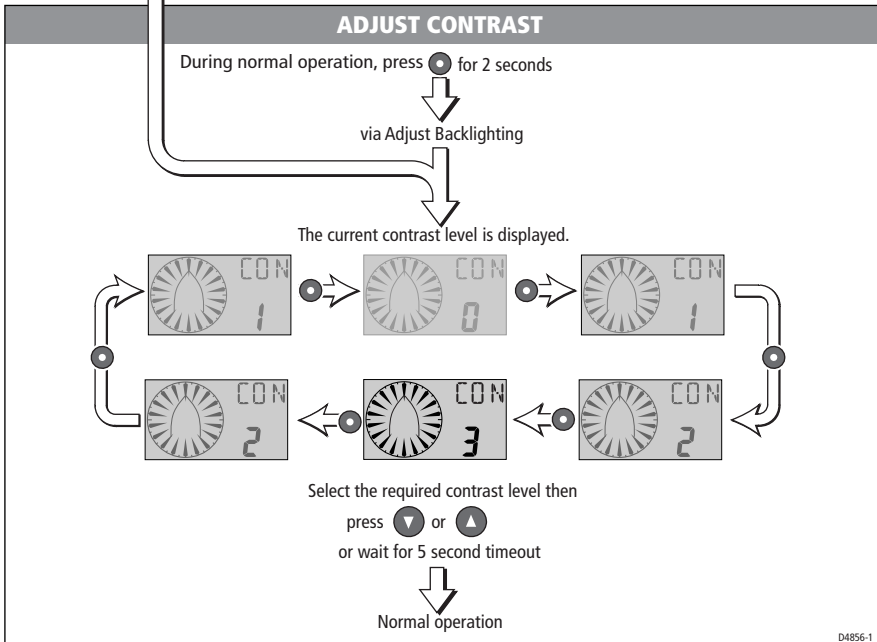
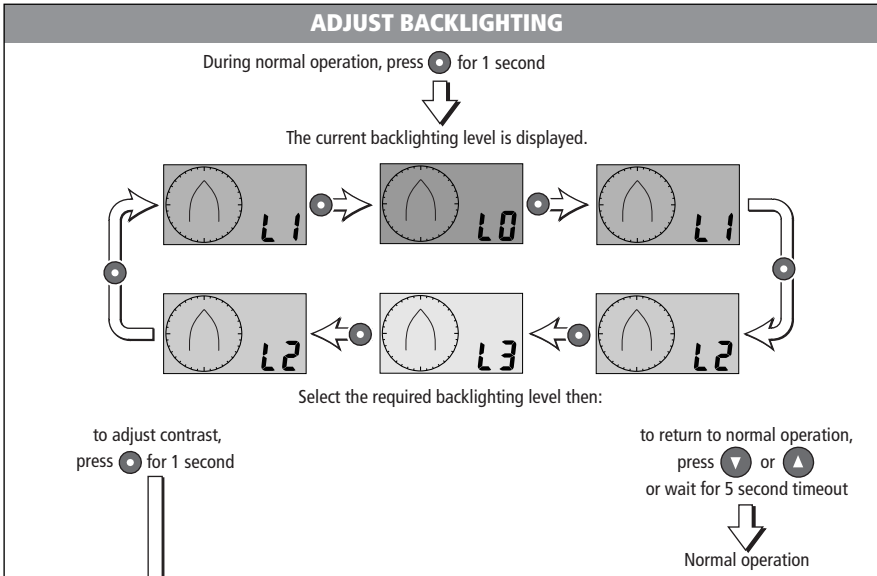

1.3 Screen descriptions

Compass heading screen

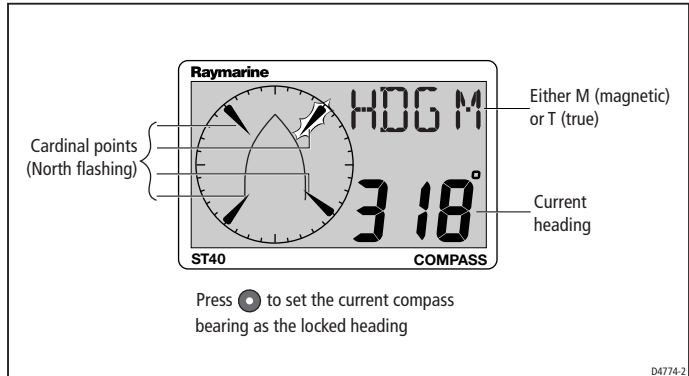

Locked heading screen

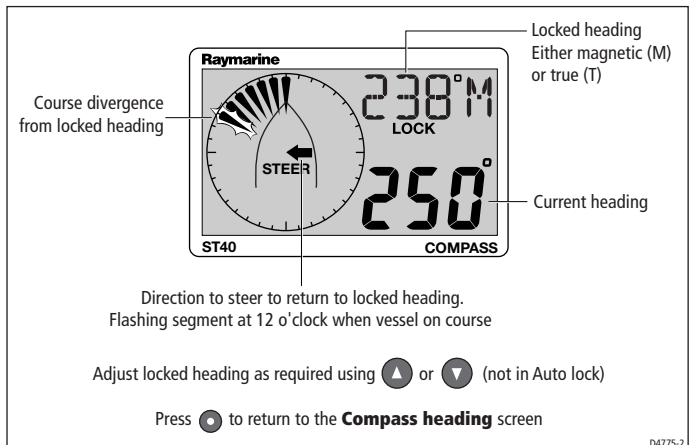

1.4 Alarms

Off course active alarm

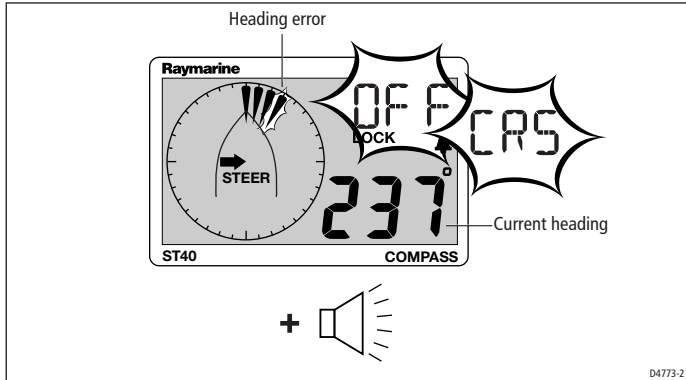

Enabling/disabling alarm

You can enable or disable the off course alarm function (i.e. switch it on or off) by selecting the Set off course alarm threshold screen (see *Normal operation*) and holding down the  key for 3 seconds (toggle action).

Man overboard alarm (repeated)

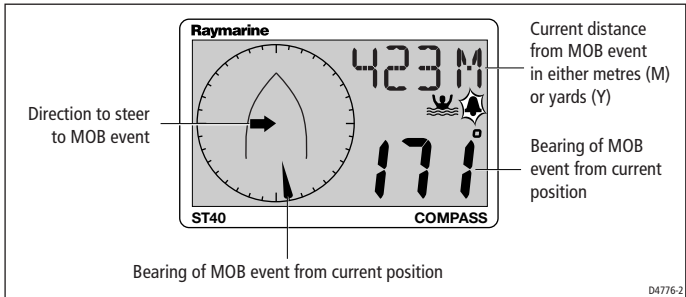

The man overboard (MOB) alarm is initiated by other SeaTalk instruments and will be displayed on the ST40 Compass instrument only if the instrument is part of a SeaTalk system. The MOB alarm cannot be cleared from the ST40 Compass instrument.

Chapter 2: Maintenance and Fault Finding

2.1 Maintenance

Servicing and safety

- Raymarine equipment should be serviced only by authorised Raymarine service technicians. They will ensure that service procedures and replacement parts used will not affect performance. There are no user-serviceable parts in any Raymarine product.
- Some products generate high voltages, so never handle the cables/connectors when power is being supplied to the equipment.
- When powered up, all electrical equipment produces electromagnetic fields. These can cause adjacent pieces of electrical equipment to interact with one another, with a consequent adverse affect on operation. In order to minimise these effects and enable you to get the best possible performance from your Raymarine equipment, guidelines are given in the installation instructions, to enable you to ensure minimum interaction between different items of equipment, i.e. ensure optimum Electromagnetic Compatibility (EMC).
- Always report any EMC-related problem to your nearest Raymarine dealer. We will use any such information to improve our quality standards.
- In some installations, it may not be possible to prevent the equipment from being affected by external influences. In general this will not damage the equipment but it can lead to spurious resetting action, or momentarily may result in faulty operation.
- Always switch off the power to Raymarine equipment before working on it.

When requesting service, please quote equipment Type, Model Number, Serial Number and, if possible, Software Release Issue. The Software Release Issue can be ascertained by means of the Intermediate Calibration facility, see *Chapter 4, Calibration*.

Instrument

Certain atmospheric conditions may cause a small amount of condensation to form on the instrument window. This will not harm the instrument and will clear after the instrument has been switched on for a short period.

Periodically clean your ST40 instrument with a soft damp cloth. Do NOT use chemical or abrasive materials to clean the instrument.

Cabling

Examine all cables for chafing or other damage to the outer shield and, where necessary, replace and re-secure.

2.2 Fault finding

Preliminary procedures

If you appear to have a problem, first check the security of the connections at the rear of the instrument and reconnect any that are loose.

Changes in the electronic environment may adversely affect the operation of your ST40 equipment. Typical examples of such changes are:

- Electrical equipment has recently been installed or moved aboard your vessel.
- You are in the vicinity of another vessel or shore station emitting radio signals.

Fixing faults

All Raymarine products are subjected to comprehensive test and quality assurance programmes prior to packing and shipping. However, if a fault occurs, the following guidelines may help to identify and rectify the problem.

Low battery

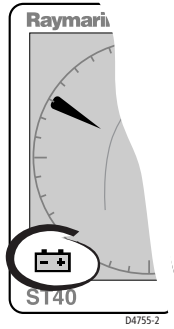

Action

Recharge your vessel's battery as soon as possible

Display blank

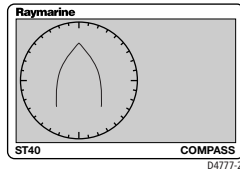

Action

- Check fuse/circuit breaker.
- Check power supply.
- Check SeaTalk cabling and connector security.

No heading information

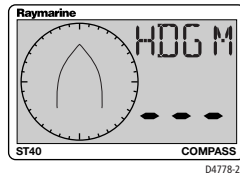

Action

Check the condition of the fluxgate compass transducer cable and the security of the connections.

SeaTalk information not being transferred between instruments

For example, backlighting level changes implemented at one instrument do not affect other instruments

Action

- Check security of SeaTalk connections between instruments.
- Check condition of SeaTalk cables.
- Isolate faulty instrument by disconnecting instruments one by one.

A group of SeaTalk instruments not working

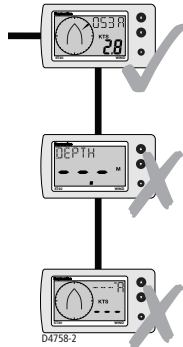

Action

Check the security of SeaTalk connectors between functioning and non-functioning instruments.

Assistance

If you are unable to rectify any problem, please contact your local Raymarine Dealer for assistance.

Chapter 3: Installation

This chapter describes how to install the ST40 Compass instrument, and associated Fluxgate Compass transducer.

3.1 Planning your installation

Determine the best positions for both transducer and instrument, such that the *EMC installation guidelines* and the *Site requirements* (below) are satisfied.

EMC installation guidelines

All Raymarine equipment and accessories are designed to the best industry standards for use in the leisure marine environment.

Their design and manufacture conform to the appropriate Electromagnetic Compatibility (EMC) standards, but correct installation is required to ensure that performance is not compromised. Although every effort has been taken to ensure that they will perform under all conditions, it is important to understand what factors could affect the operation of the product.

The guidelines given here describe the conditions for optimum EMC performance, but it is recognised that it may not be possible to meet all of these conditions in all situations. To ensure the best possible conditions for EMC performance within the constraints imposed by any location, always ensure the maximum separation possible between different items of electrical equipment.

For **optimum** EMC performance, it is recommended that **wherever possible**:

- All Raymarine equipment and cables connected to it are:
 - At least 1 m (3 feet) from any equipment transmitting or cables carrying radio signals e.g. VHF radios, cables and antennas. In the case of SSB radios, the distance should be increased to 2 m (7 ft).
 - More than 2 m (7 ft) from the path of a radar beam. A radar beam can normally be assumed to spread 20 degrees above and below the radiating element.

- The equipment is supplied from a different battery from that used for engine start. Voltage drops below 10 V in the power supply to our products, and starter motor transients, can cause the equipment to reset. This will not damage the equipment, but may cause the loss of some information and may change the operating mode.
- Raymarine specified cables are used at all times. Cutting and rejoining these cables can compromise EMC performance and so must be avoided unless doing so is detailed in the installation manual.
- If a suppression ferrite is attached to a cable, this ferrite should not be removed. If the ferrite needs to be removed during installation it must be reassembled in the same position.

Suppression Ferrites

The following illustration shows typical cable suppression ferrites fitted to Raymarine equipment. Always use the ferrites supplied by Raymarine.

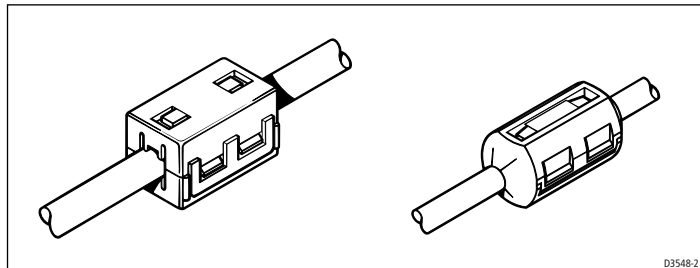

Connections to Other Equipment

If your Raymarine equipment is going to be connected to other equipment using a cable not supplied by Raymarine, a suppression ferrite **MUST** always be fitted to the cable close to the Raymarine unit.

Tools required

The tools required for fitting the standard ST40 instrument system are shown in the following illustration.

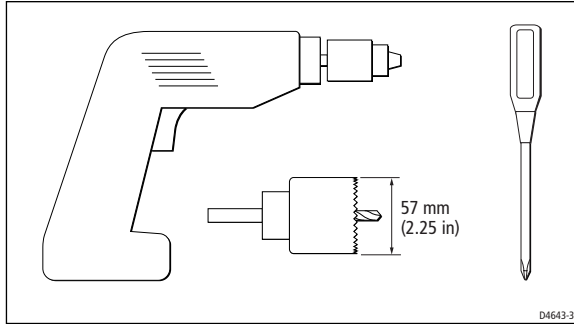

Note: *If you intend fitting a nonstandard transducer, extra tools may be required.*

Site requirements

Fluxgate Compass transducer

The Fluxgate Compass transducer should be positioned as near as possible to the pitch/roll centre of the vessel, as shown in the shaded areas below.

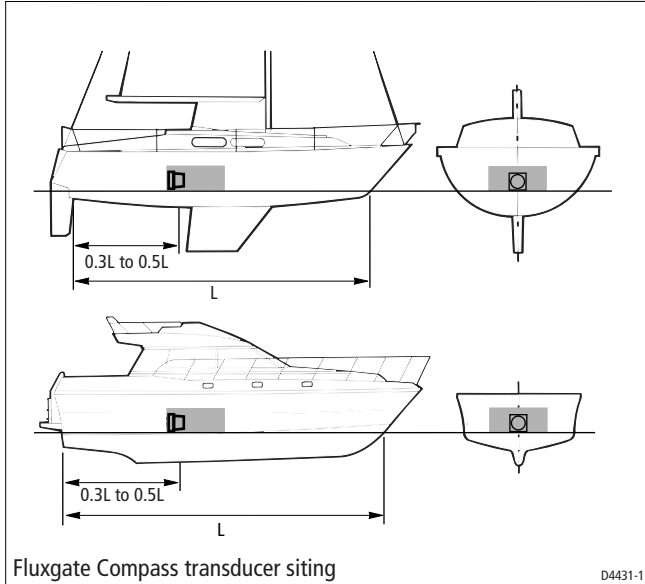

The Fluxgate Compass transducer must also be sited:

- At least 0.8 m (2 ft 6 in) away from the vessel's steering compass to avoid deviation in both compasses.
- On a bulkhead below deck.

Note: *On steel vessels the Fluxgate Compass transducer can be mounted above deck. When mounted above deck, performance may be impaired due to increased motion.*

- To allow reasonable access for installation and servicing.
- Away from any equipment or other installation which may shield the transducer or otherwise disturb the earth's magnetic field, e.g. large ferrous or magnetic items, engines, communications equipment or cabling.
- On a vertical mounting surface. Where necessary, make up a suitable nonferrous wedged packing piece to provide the necessary vertical surface.

Instrument

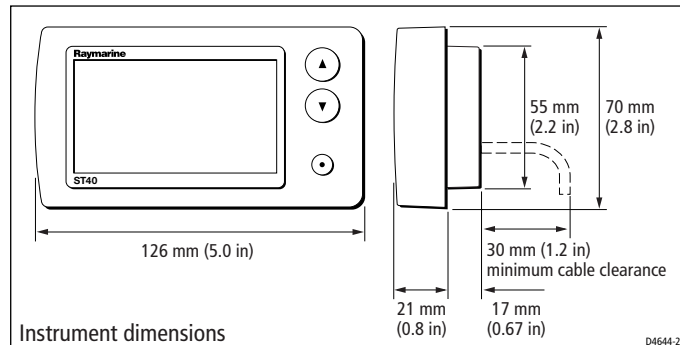

CAUTION:

The presence of moisture at the rear of the instrument could cause damage either by entering the instrument through the breathing hole or by coming into contact with the electrical connectors.

Each instrument must be positioned where:

- It is easily read by the helmsman or navigator
- It is protected against physical damage
- It is at least 230 mm (9 in) from a compass
- There is reasonable rear access for installation and servicing
- The rear of the instrument is protected from water.

3.2 Procedures

Adapt these procedures as appropriate, to suit your individual requirement.

CAUTION:

Where it is necessary to cut holes (e.g. for cable routing and instrument mounting), ensure that these will not cause a hazard by weakening critical parts of the vessel's structure. If in doubt, seek advice from a reputable boat builder.

Fitting Fluxgate Compass transducer

Introduction

Stand alone instrument

If you are fitting the ST40 Compass instrument as a stand alone instrument, you should also fit the Fluxgate Compass transducer and connect it directly to the instrument.

System requirements

If you intend fitting the ST40 Compass instrument as part of an instrument system, you must ensure that only one Fluxgate Compass transducer is connected to the system.

In such a system, the master steering compass instrument is the one to which the Fluxgate Compass transducer is directly connected. Other compass instruments in the system repeat information from this master.

Note: *The Fluxgate Compass transducer can be connected to a course computer instead of a compass instrument. The course computer then provides the master compass information for the system.*

Installation

Determine a suitable position for the Fluxgate Compass transducer, as described under *Site requirements*.

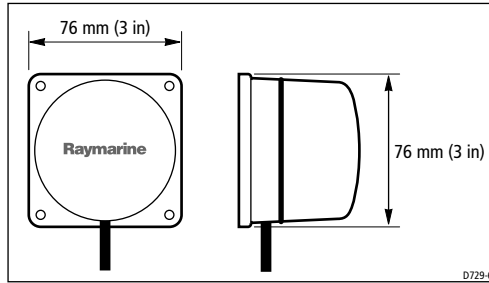

If you are not sure of the magnetic suitability of the chosen location, carry out a survey of the site as follows:

1. Temporarily fix a simple hand bearing compass at the intended location.
2. Swing the vessel through 360° while at the same time observing differences between the hand bearing compass and the vessel's main steering compass.
3. If there are no differences, greater than 10° on any heading, then the site is suitable for the Fluxgate Compass transducer.

Using the self-tapping screws provided, mount the Fluxgate Compass transducer vertically on a suitable bulkhead, so that the connecting cable is downmost.

Running transducer cable

Observing the following guidelines, run the transducer cable to the instrument:

- If the cable has to be fed through the deck, always use a good quality deck gland.
- Where cables are fed through holes, always use grommets to prevent chafing.
- Secure long cable runs so they do not present a hazard.
- Wherever possible, route the cable away from fluorescent lights, engines, radio transmitting equipment, as these may cause interference.

Connections to the instrument

You can connect your instrument:

- Directly to the compass transducer as a stand-alone master instrument. When connected in this manner, the instrument must be connected to a suitable power source using the 1 m (3 ft) power cable provided.
- As part of a SeaTalk system either as a repeater or, with a transducer also connected as a system master. To connect to SeaTalk, you will need an additional SeaTalk Interconnection Kit (Part No. E25028). When connected in this manner, power can be provided from the SeaTalk bus (e.g. from the autopilot).

Provided there is no other Fluxgate Compass already connected to SeaTalk, you can connect the instrument to both the compass transducer and SeaTalk. When thus connected, the instrument will be the master compass instrument for the SeaTalk system.

If it is necessary to fit spade connectors to the transducer cable, do so as shown in the following illustration. Prepare the cable, as at (a), and fit the spade connectors as at (b). When fitting each spade connector, ensure that wire strands do not extend beyond the rear of the spade connector insulation.

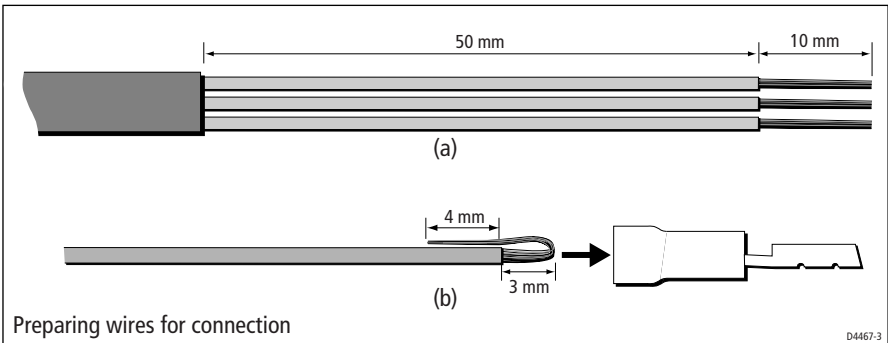

Stand-alone connections

CAUTION

Ensure that the power supply for each stand-alone ST40 instrument is protected by a 3 A fuse or circuit breaker.

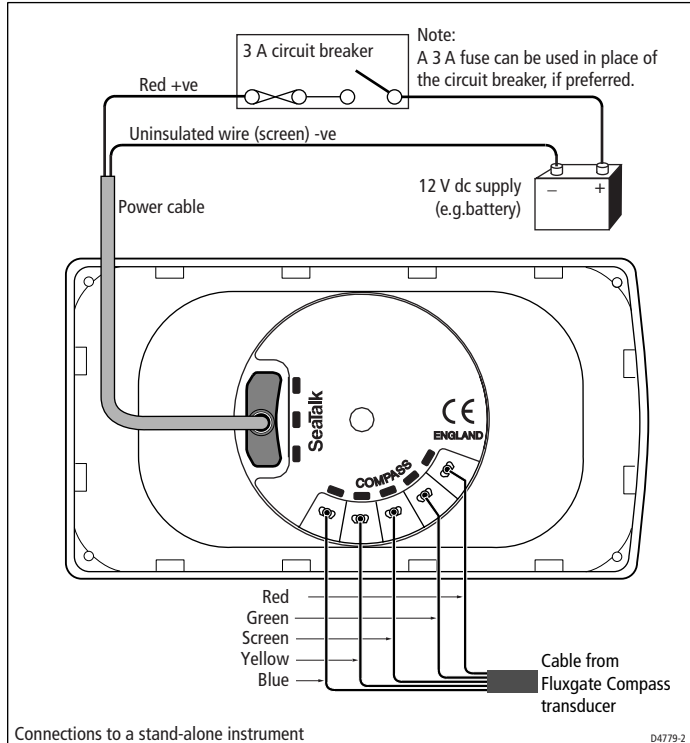

SeaTalk connections

CAUTION

When instruments are connected to SeaTalk, ensure that the power supply for the SeaTalk 12 V line is protected by a 5 A fuse or circuit breaker.

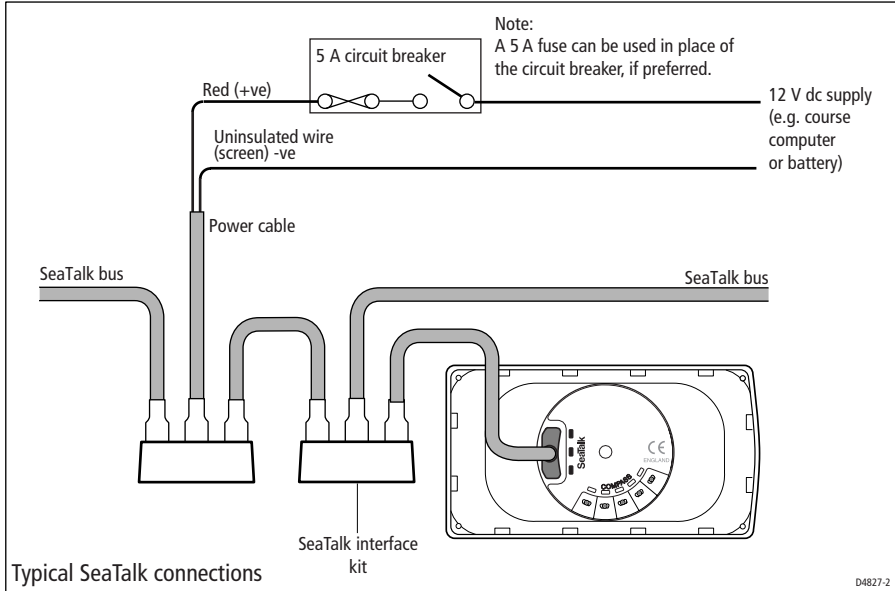

Fitting the instrument

Fit your ST40 instrument as shown in the following illustrations.

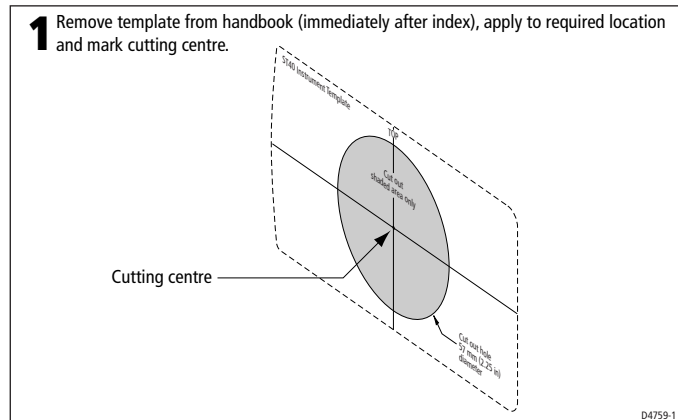

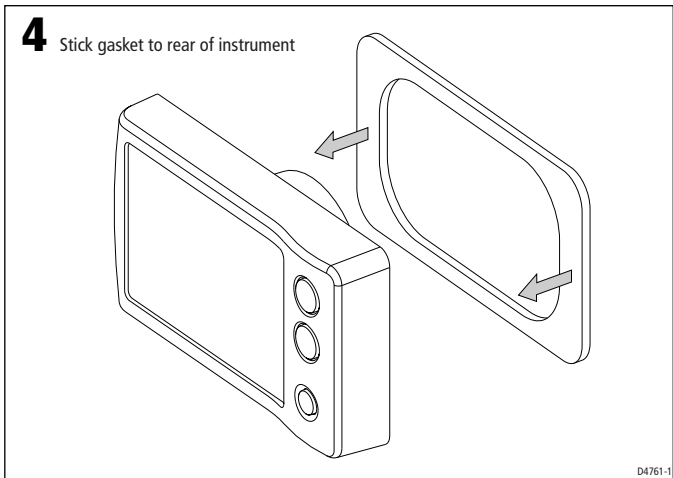
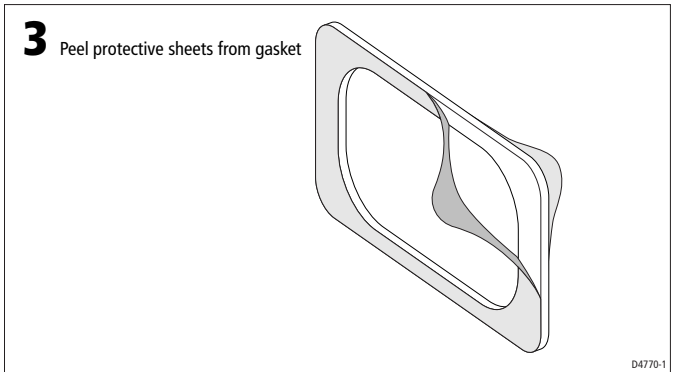
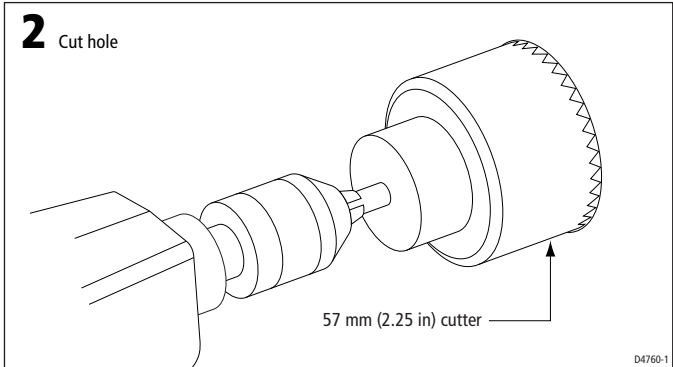

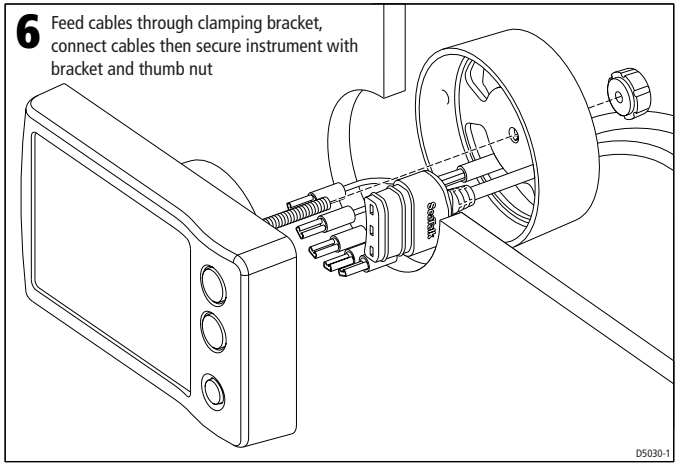
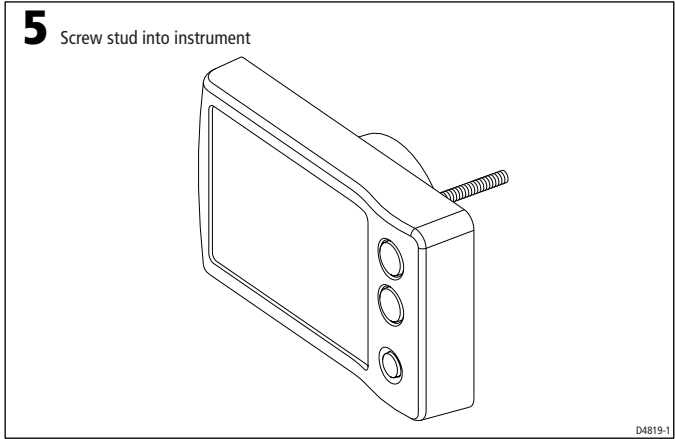

Desktop Mounting Bracket

An optional Desktop Mounting Bracket (Part No. E25024) enables you to mount your ST40 instrument in locations where other forms of mounting are impractical.

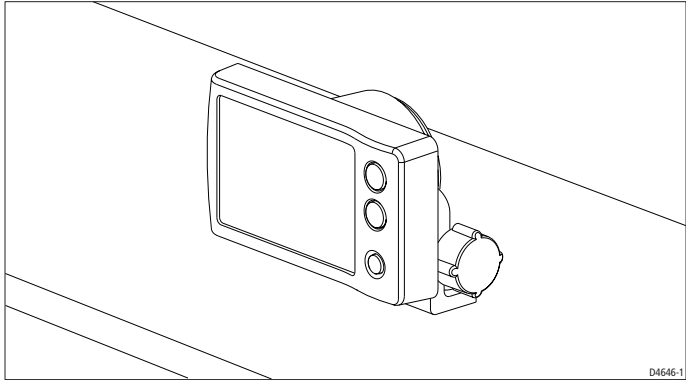

To bracket mount your ST40 instrument, do so in accordance with the *Instruction Sheet*, which is included with the Desktop Mounting Bracket.

3.3 Calibration requirement

Once installation is complete and before you use your instrument, carry out the calibration procedures detailed in *Chapter 4, Calibration*.

Chapter 4: Calibration

4.1 Introduction

The procedures in this Chapter must be carried out before the equipment is used operationally, to optimise the performance of the instrument with the vessel.

Calibration information is presented in flow chart form. The flow charts show the various calibration screens and key presses necessary to carry out calibration. All key presses are momentary unless otherwise stated.

EMC conformance

- Always check the installation before going to sea to make sure that it is not affected by radio transmissions, engine starting etc.

4.2 User calibration

User calibration enables you to:

- Set the compass heading response values. Use higher response values for rapid updates in reasonable sea conditions (for example when you are trying to maintain a locked course). Use lower response values in choppy sea conditions to damp out unstable readings.
- Set the magnetic variation.
- Set the heading reference (magnetic or true).
- Linearise and align the compass.

Power up the instrument then follow the procedure in the *User calibration* flow diagram.

USER CALIBRATION

During normal operation
hold down  and  for approximately 2 seconds

Entry screen

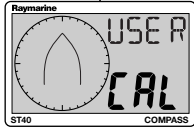

Note:
If there is no key activity when the **Entry screen** is displayed, calibration will time out to normal operation after 5 seconds,

Set compass heading response

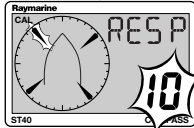

15 (fast)
1 (slow)

Set variation

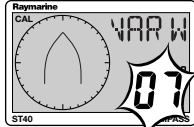

Increase value
Decrease value

Set True/Magnetic

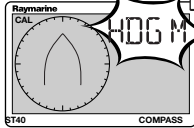

HDGT

Set heading alignment

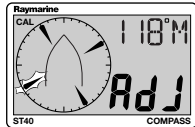

Flashing segment = North

Increase
Decrease

Deviation

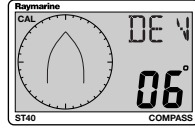

When linearisation successful
(3 beeps)

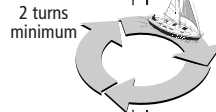

2 turns minimum

To linearise compass

To bypass linearisation

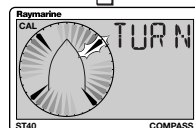

Linearise transducer



If vessel is turned too fast during linearisation, a SLO legend is displayed

Repeater

Master

To save your settings and return to normal operation from any screen,
hold down  and  for approximately 2 seconds

4.3 Intermediate calibration

Intermediate calibration enables you to:

- Check the instrument software version.
- Check the instrument status - either master (shown as RPTR NO) or repeater (shown as RPTR YES).

You cannot make any adjustments in Intermediate calibration.

Follow the procedure in the *Intermediate calibration* flow diagram.

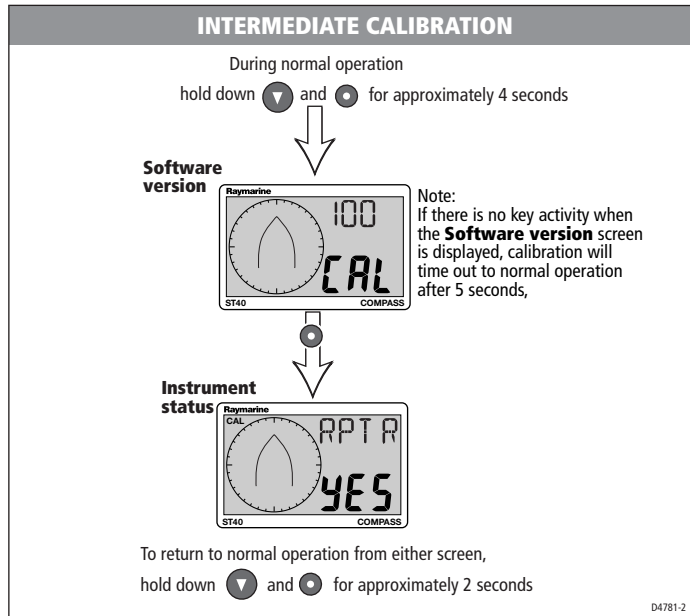

4.4 Dealer calibration



Dealer calibration enables you to set:

- User calibration on/off.
- Boat show mode on/off.

Dealer calibration also gives access to the **Factory defaults** screen. This enables you to reapply the factory settings if you want to reset the instrument to a known operating condition.

Follow the procedure in the *Dealer calibration* flow diagram.

DEALER CALIBRATION

During normal operation
hold down  and  for approximately 12 seconds

Entry screen

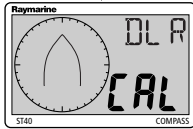

Note:
If there is no key activity when the **Entry screen** is displayed, calibration will time out to normal operation after 5 seconds,

Calibration access

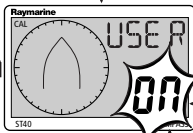

OFF

If **NO**

If **YES**

Return to normal operation with factory defaults applied

Boat show mode

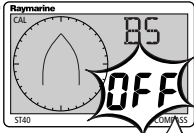

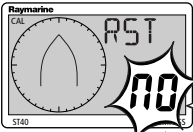

Factory defaults



YES

CAUTION:
Do NOT switch the Boat Show mode on.
This function must only be used for demonstration purposes.

To save your settings and return to normal operation from any screen,
hold down  and  for approximately 2 seconds

Instrument Specification

Supply voltage:	10 V to 16 V dc.
Current consumption (12 V supply):	20 mA typical. 60 mA with maximum backlighting.
Operating temperature:	0°C to +70°C.
Interfaces:	SeaTalk.
Overall dimensions:	126 mm x 70 mm x 38 mm (5.00 inches x 2.80 inches x 1.55 inches).
Boss diameter:	55 mm (2.20 inches).
Heading range:	0 to 359°.
Off course alarm:	2° to 30° (port or starboard).
Approvals:	
CE - conforms to	89/336/EC(EMC), EN60945. 94/25/EC(RCD), EN28846 (applies to transducer only).

Glossary

EMC Electromagnetic Compatibility.

M Metres.

MOB Man overboard.

Response The rate at which an instrument responds to changes in heading. Values are from 1 (slow response) to 15 (fast response).

SeaTalk SeaTalk is a proprietary Raymarine system which links different compatible products, to provide a single, integrated navigational system. SeaTalk can also communicate with non-SeaTalk equipment using the internationally- accepted National Marine Electronics Association (NMEA) protocol. Contact your Raymarine dealer for details.

Y Yards.

Index

A

- Alarms
 - indications 5
 - man overboard 5
 - off course 5, 27
 - silencing 1
- Aligning heading 24

B

- Backlighting 3
- Boat show mode 25

C

- Calibration 23–26
 - Dealer 25–26
 - Intermediate 25
 - setting user access 26
 - User 23–24
- Calibration requirement 1, 22
- Cleaning the instrument 8
- Compass heading
 - appropriate response values 23
 - screen 2, 4
 - setting response 24
- Condensation 8
- Connecting the instrument 17–19
- Contrast 3
- Current consumption 27

D

- Dealer calibration 25–26
- Desktop Mounting Bracket 21–22
- Dimensions 27

E

- EMC
 - conformance i, 23
 - installation guidelines 11

F

- Factory defaults 25
- Fault finding 8
 - assistance 10
 - blank display 9
 - low battery 9
 - no heading information 9
 - SeaTalk problems 9
- Fluxgate Compass transducer
 - checking suitability of site 16
 - fitting 15–16
 - fitting as part of a system 15
 - installing 15
 - site requirements 13
 - with stand alone instrument 15

H

- Heading
 - aligning 24
 - range 27

I

- Installation 11–22
 - connections to the instrument 17–19
 - Fluxgate Compass transducer 15–16
 - instrument 19–22
 - planning 11–14
 - site requirements 13–15
 - tools required 12–13
- Instrument
 - cleaning 8
 - condensation 8
 - connections 17–19
 - current consumption 27
 - dimensions 27
 - fitting 19–22
 - site requirements 14
 - status (master or repeater) 25
 - supply voltage 27
- Intermediate calibration 25

L

- Linearising transducer 24
- Locked heading 2
 - auto 2
 - response 24
 - screen 4
- Low battery indication 9

M

- Maintenance 7–8
- Man overboard alarm 5

O

- Off course alarm
 - enabling 2
 - enabling/disabling 5
 - indications 5
 - range 27
 - setting 2
- Operating procedures 1–5
- Operating temperature 27

P

- Panel lighting 3
- Parts supplied vi

S

- Servicing and safety 7
- Setting
 - backlighting 3
 - compass heading response 24
 - contrast 3
 - heading alignment 24
 - locked heading response 24
 - off course alarm 2
 - true or magnetic compass heading 24
 - variation 24
- Silencing alarm 1
- Site requirements 13–14
 - Fluxgate Compass transducer 13
 - instrument 14
- Software version 25
- Specifications 27

T

- Transducer
 - linearising 24–25

U

- User calibration 23–24

V

- Variation 24
- Voltage 27

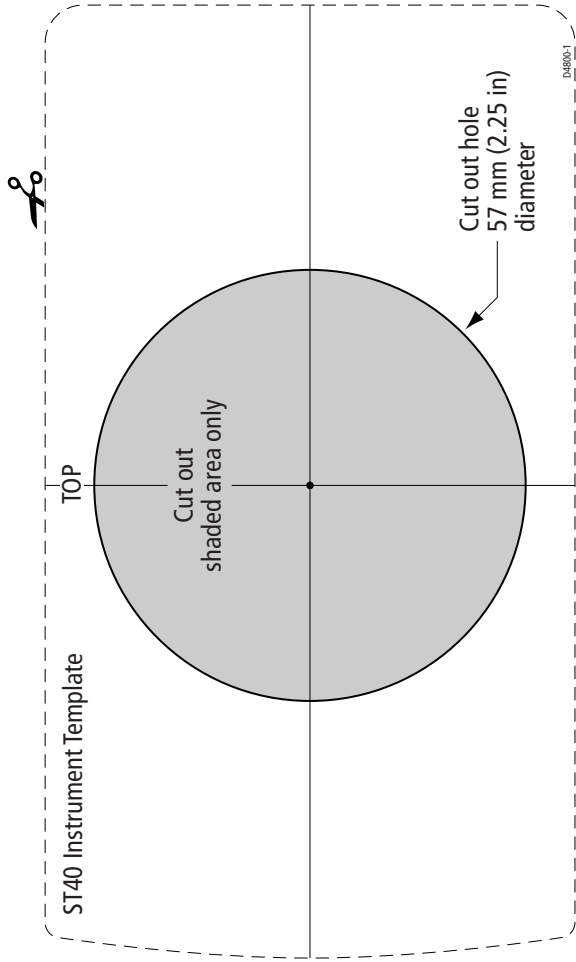

Limited Warranty Certificate

Raymarine warrants each new Light Marine/Dealer Distributor Product to be of good materials and workmanship, and will repair or exchange any parts proven to be defective in material and workmanship under normal use for a period of 2 years/24 months from date of sale to end user, except as provided below.

Defects will be corrected by Raymarine or an authorized Raymarine dealer. Raymarine will, except as provided below, accept labor cost for a period of 2 years/24 months from the date of sale to end user. During this period, except for certain products, travel costs (auto mileage and tolls) up to 100 round trip highway miles (160 kilometres) and travel time of 2 hours, will be assumed by Raymarine only on products where proof of installation or commission by authorized service agents, can be shown.

Warranty Limitations

Raymarine Warranty policy does not apply to equipment which has been subjected to accident, abuse or misuse, shipping damage, alterations, corrosion, incorrect and/or non-authorized service, or equipment on which the serial number has been altered, mutilated or removed.

Except where Raymarine or its authorized dealer has performed the installation, it assumes no responsibility for damage incurred during installation.

This Warranty does not cover routine system checkouts or alignment/calibration, unless required by replacement of part(s) in the area being aligned.

A suitable proof of purchase, showing date, place, and serial number must be made available to Raymarine or authorized service agent at the time of request for Warranty service.

Consumable items, (such as: Chart paper, lamps, fuses, batteries, styli, stylus/drive belts, radar mixer crystals/diodes, snap-in impeller carriers, impellers, impeller bearings, and impeller shaft) are specifically excluded from this Warranty.

Magnetrons, Cathode Ray Tubes (CRT), TFT Liquid Crystal Displays (LCD) and cold cathode fluorescent lamps (CCFL), hailer horns and transducers are warranted for 1 year/12 months from date of sale. These items must be returned to a Raymarine facility.

All costs associated with transducer replacement, other than the cost of the transducer itself, are specifically excluded from this Warranty.

Overtime premium labor portion of services outside of normal working hours is not covered by this Warranty.

Travel cost allowance on certain products with a suggested retail price below \$2500.00 is not authorized. When/or if repairs are necessary, these products must be forwarded to a Raymarine facility or an authorized dealer at owner's expense will be returned via surface carrier at no cost to the owner.

Travel costs other than auto mileage, tolls and two (2) hours travel time, are specifically excluded on all products. Travel costs which are excluded from the coverage of this Warranty include but are not limited to: taxi, launch fees, aircraft rental, subsistence, customs, shipping and communication charges etc. Travel costs, mileage and time, in excess to that allowed must have prior approval in writing.

TO THE EXTENT CONSISTENT WITH STATE AND FEDERAL LAW:

(1) THIS WARRANTY IS STRICTLY LIMITED TO THE TERMS INDICATED HEREIN, AND NO OTHER WARRANTIES OR REMEDIES SHALL BE BINDING ON RAYMARINE INCLUDING WITHOUT LIMITATION ANY WARRANTIES OF MERCHANTABILITY OR FITNESS FOR A PARTICULAR PURPOSE.

(2) Raymarine shall not be liable for any incidental, consequential or special (including punitive or multiple) damages.

All Raymarine products sold or provided hereunder are merely aids to navigation. It is the responsibility of the user to exercise discretion and proper navigational skill independent of any Raymarine equipment.

Raymarine

Factory Service Centers

United States of America

Raymarine Inc
22 Cotton Road, Unit D
Nashua, NH 03063-4219, USA

Telephone: +1 603 881 5200
Fax: +1 603 864 4756
www.raymarine.com

Sales & Order Services

Telephone: +1 800 539 5539 Ext. 2333 or
+1 603 881 5200 Ext. 2333

Technical Support

Telephone: +1 800 539 5539 Ext. 2444 or
+1 603 881 5200 Ext. 2444
Email: techsupport@raymarine.com

Product Repair Center

Telephone: +1 800 539 5539 Ext. 2118

UK, Europe, Middle East, Far East

Raymarine Ltd
Anchorage Park, Portsmouth
PO3 5TD, England

Telephone: +44 (0)23 9269 3611
Fax: +44 (0)23 9269 4642
www.raymarine.com

Customer Support

Telephone: +44 (0)23 9271 4713
Fax: +44 (0)23 9266 1228

Email: techsupport@raymarine.com

Stick barcode label here

Purchased from

Purchase date

Dealer address

Installed by

Installation date

Commissioned by

Commissioning date

Owner's name

Mailing address

This portion should be completed and retained by the owner.