



## INSTRUCTION MANUAL

# VHF MARINE TRANSCEIVER **IC-M88**

This device complies with Part 15 of the FCC Rules. Operation is subject to the condition that this device does not cause harmful interference.

**Icom Inc.**



Thank you for choosing this Icom product.  
This product is designed and built with Icom's state of the art technology and craftsmanship. With proper care, this product should provide you with years of trouble-free operation.

---

## IMPORTANT

---

**READ ALL INSTRUCTIONS** carefully and completely before using the transceiver.

**SAVE THIS INSTRUCTION MANUAL**—This instruction manual contains important operating instructions for the IC-M88 VHF MARINE TRANSCEIVER.

---

## EXPLICIT DEFINITIONS

---

WORD	DEFINITION
⚠ <b>DANGER!</b>	Personal death, serious injury or an explosion may occur.
⚠ <b>WARNING!</b>	Personal injury, fire hazard or electric shock may occur.
<b>CAUTION</b>	Equipment damage may occur.
<b>NOTE</b>	If disregarded, inconvenience only. No risk of personal injury, fire or electric shock.

---

## FEATURES

---

### 👉 **22 free channels for land use**

The IC-M88 has 22 free channels reserved for Land use (146 ~ 174 MHz). Narrow channel spacing is settable for each channel, and CTCSS and DTCS signaling is included.

\*Appropriate license will be required.

### 👉 **Tough waterproof construction**

The IC-M88 is built tough to withstand hazardous and un-hospitable environments at sea and on land. Even if the IC-M88 is dropped into water, its waterproofing\* will protect it from harm. The compact and durable body meets the military specifications (MIL-STD).

\* Equivalent to IPX7 of the corresponding International Standard IEC 529 (1989). (1m depth for 30 minutes)

### 👉 **Simple operation**

6 clearly labelled buttons on the front panel and the volume/power knob maximize simplicity of operation. Even when wearing gloves, the large buttons are easy to operate. A large, clear LCD with backlighting and backlit buttons make night time operation simple.

Icom, Icom Inc. and Icom logo are registered trademarks of Icom Incorporated (Japan) in Japan, the United States, United Kingdom, Germany, France, Spain, Russia, Australia, New Zealand, and/or other countries.

---

## RECOMMENDATION

---

**CLEAN THE TRANSCEIVER THOROUGHLY WITH FRESH WATER** after exposure to saltwater, and dry it before operating. Otherwise, the transceiver's keys, switches and controllers may become unusable, due to salt crystallization, and/or the charging terminals of the battery pack may rust.

**NOTE:** If the transceiver's waterproof protection appears defective, carefully clean it with a soft, wet (fresh water) cloth, then, dry it before operating.

The transceiver may lose its waterproof protection if the case, jack cover, or the battery pack is cracked or broken, or the transceiver has been dropped.

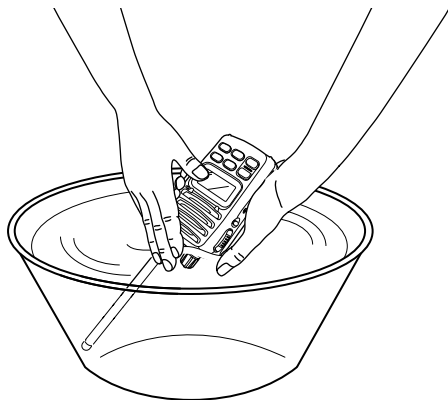

---

## IN CASE OF EMERGENCY

---

If your vessel requires assistance, contact other vessels and the Coast Guard by sending a distress call on Channel 16.

### **USING CHANNEL 16**

#### **DISTRESS CALL PROCEDURE**

1. "MAYDAY MAYDAY MAYDAY."
2. "THIS IS ....." (name of vessel)
3. Your call sign or other indication of the vessel.
4. "LOCATED AT ....." (your position)
5. The nature of the distress and assistance required.
6. Any other information which might facilitate the rescue.

---

## SAFETY TRAINING INFORMATION

---



### WARNING

Your Icom radio generates RF electromagnetic energy during transmit mode. This radio is designed for and classified as “Occupational Use Only”, meaning it must be used only during the course of employment by individuals aware of the hazards, and the ways to minimize such hazards. This radio is NOT intended for use by the “General Population” in an uncontrolled environment.

This radio has been tested and complies with the FCC and IC RF exposure limits for “Occupational Use Only”. In addition, your Icom radio complies with the following Standards and Guidelines with regard to RF energy and electromagnetic energy levels and evaluation of such levels for exposure to humans:

- FCC OET Bulletin 65 Edition 97-01 Supplement C, Evaluating Compliance with FCC Guidelines for Human Exposure to Radio Frequency Electromagnetic Fields.
- American National Standards Institute (C95.1-1992), IEEE Standard for Safety Levels with Respect to Human Exposure to Radio Frequency Electromagnetic Fields, 3 kHz to 300 GHz.
- American National Standards Institute (C95.3-1992), IEEE Recommended Practice for the Measurement of Potentially Hazardous Electromagnetic Fields— RF and Microwave.
- The following accessories are authorized for use with this product. Use of accessories other than those specified may result in RF exposure levels exceeding the FCC and IC requirements for wireless RF exposure: Swivel Belt Clip (MB-86), Rechargeable Li-ion Battery Pack (BP-227UL), and Speaker-microphone (HM-168IS).



### CAUTION

**To ensure that your expose to RF electromagnetic energy is within the FCC and IC allowable limits for occupational use, always adhere to the following guidelines:**

- **DO NOT** operate the radio without a proper antenna attached, as this may damage the radio and may also cause you to exceed FCC and IC RF exposure limits. A proper antenna is the antenna supplied with this radio by the manufacturer or antenna specifically authorized by the manufacturer for use with this radio.
- **DO NOT** transmit for more than 50% of total radio use time (“50% duty cycle”). Transmitting more than 50% of the time can cause FCC and IC RF exposure compliance requirements to be exceeded. The radio is transmitting when the transmit icon is displayed. You can cause the radio to transmit by pressing the “PTT” switch.
- **ALWAYS keep** the antenna at least 2.5 cm (1 inch) away from the body when transmitting and only use the Icom belt-clips which are listed on page 35 when attaching the radio to your belt, etc., to ensure FCC and IC RF exposure compliance requirements are not exceeded. To provide the recipients of your transmission the best sound quality, hold the antenna at least 5 cm (2 inches) from your mouth, and slightly off to one side.

The information listed above provides the user with the information needed to make him or her aware of RF exposure, and what to do to assure that this radio operates within the FCC and IC RF exposure limits of this radio.

### Electromagnetic Interference/Compatibility

During transmissions, your Icom radio generates RF energy that can possibly cause interference with other devices or systems. To avoid such interference, turn off the radio in areas where signs are posted to do so. **DO NOT** operate the transmitter in areas that are sensitive to electromagnetic radiation such as hospitals, aircraft, and blasting sites.

### Occupational/Controlled Use

The radio transmitter is used in situations in which persons are exposed as a consequence of their employment provided those persons are fully aware of the potential for exposure and can exercise control over their exposure.

---

## PRECAUTIONS

---

⚠ **DANGER! NEVER** short the terminals of the battery pack. Also, current may flow into metal objects such as a key, so be careful when placing the battery packs (or the transceiver) in bags, and so on. Simply carrying with or placing near metal objects such as a key, and so on, may cause shorting. This may damage not only the battery pack, but also the transceiver.

⚠ **DANGER!** Use and charge only specified Icom battery packs with Icom transceivers or Icom chargers. Only Icom battery packs are tested and approved for use with Icom transceivers or charged with Icom chargers. Using third-party or counterfeit battery packs or chargers may cause smoke, fire, or cause the battery to burst.

⚠ **DANGER!** Use only HM-168IS SPEAKER MICROPHONE. Only HM-168IS is tested and approved for use with the transceiver. Using third-party or counterfeit microphone may present a risk of fire or explosion.

⚠ **DANGER! NEVER** operate the transceiver near unshielded electrical blasting caps or in an explosive atmosphere.

⚠ **WARNING! NEVER** hold the transceiver so that the antenna is closer than 2.5 cm (1 inch) from exposed parts of the body, especially the face or eyes, while transmitting.

**CAUTION: NEVER** connect the transceiver to a power source other than the products specified by Icom. Such a connection will ruin the transceiver.

**CAUTION: MAKE SURE** the flexible antenna, battery pack and jack cover are securely attached to the transceiver, and that the antenna and battery pack are dry before attachment. Exposing the inside of the transceiver to dust or water will result in serious damage to the transceiver. After exposure to water, clean the battery contacts thoroughly with fresh water and dry them completely to remove any water or salt residue.

**DO NOT** place or leave the transceiver in direct sunlight or in areas with temperatures below  $-20^{\circ}\text{C}$  ( $-4^{\circ}\text{F}$ ) or above  $+60^{\circ}\text{C}$  ( $+140^{\circ}\text{F}$ ): Marine, below  $-30^{\circ}\text{C}$  ( $-22^{\circ}\text{F}$ ) or above  $+60^{\circ}\text{C}$  ( $+140^{\circ}\text{F}$ ): LMR.

**DO NOT** use harsh solvents such as Benzine or alcohol when cleaning, as they will damage the transceiver surfaces.

**DO NOT** push [PTT] when not actually intending to transmit.

**DO NOT** modify the transceiver. The transceiver warranty does not cover any problems caused by unauthorized modification.

---

## PRECAUTIONS (Continued)

---

**KEEP** the transceiver out of the reach of unauthorized persons.

**KEEP** the transceiver at least 0.9 meters (3.0 ft) away from your vessel's magnetic navigation compass.

**BE CAREFUL!** The transceiver meets IPX7\* requirements for waterproof protection. However, once the transceiver has been dropped, waterproof protection cannot be guaranteed because of possible damage to the transceiver's case or the waterproof seal.

\* Only when the battery pack, flexible antenna, [SP MIC] jack cover is attached.

**MAKE SURE** to turn OFF the transceiver before connecting or disconnecting the supplied or optional accessory.

This equipment is suitable for use in Class I, Division 2, Groups A, B, C, and D or non-hazardous locations only.

**WARNING: EXPLOSION HAZARD** - Substitution of any components may impair suitability for Class I, Division 2.

Replace Li-ion battery pack model number BP-227UL manufactured by Icom only. Use of another battery pack may present a risk of fire or explosion.

Replace speaker microphone accessory model number HM-168IS manufactured by Icom only. Use of another accessory may present a risk of fire or explosion.

---

## FCC INFORMATION

---

**• FOR CLASS A UNINTENTIONAL RADIATORS:**

This equipment has been tested and found to comply with the limits for a Class A digital device, pursuant to part 15 of the FCC Rules. These limits are designed to provide reasonable protection against harmful interference when the equipment is operated in a commercial environment. This equipment generates, uses, and can radiate radio frequency energy and, if not installed and used in accordance with the instruction manual, may cause harmful interference to radio communications. Operation of this equipment in a residential area is likely to cause harmful interference in which case the user will be required to correct the interference at his own expense.

**CAUTION:** Changes or modifications to this device, not expressly approved by Icom Inc., could void your authority to operate this device under FCC regulations.

Icom is not responsible for the destruction or damage to the Icom transceiver, if the malfunction is because of:

- Force majeure, including, but not limited to, fires, earthquakes, storms, floods, lightning, other natural disasters, disturbances, riots, war, or radioactive contamination.
- The use of Icom transceivers with any equipment that is not manufactured or approved by Icom.

---

# TABLE OF CONTENTS

---

IMPORTANT .....	i
EXPLICIT DEFINITIONS .....	i
FEATURES .....	i
RECOMMENDATION .....	ii
IN CASE OF EMERGENCY .....	ii
SAFETY TRAINING INFORMATION .....	iii
PRECAUTIONS .....	iv
PRECAUTIONS (Continued) .....	v
FCC INFORMATION .....	v
<b>1 OPERATING RULES.....</b>	<b>1</b>
◇ Priorities .....	1
◇ Privacy .....	1
◇ Radio licenses .....	1
<b>2 SUPPLIED ACCESSORIES AND ATTACHMENTS....</b>	<b>2–3</b>
■ Supplied accessories .....	2
■ Attachments .....	2
◇ Swivel belt clip .....	2
◇ Flexible antenna .....	3
◇ Handstrap .....	3
<b>3 PANEL DESCRIPTION.....</b>	<b>4–7</b>
■ Front, top and side panels .....	4
◇ Battery pack release button .....	5
■ Function display .....	6
<b>4 BASIC OPERATION.....</b>	<b>8–12</b>
■ Selecting a Channel .....	8
◇ Channel 16 .....	8
◇ Channel 9 (Call channel) .....	8
◇ USA, International and Canadian channels .....	9
◇ Weather channels (Available for USA version only) .....	9
■ Receiving and transmitting .....	10
■ Adjusting the squelch level .....	11
■ Automatic backlight .....	11
■ Lock function .....	11
■ Setting the Call channel .....	12
<b>5 SCAN OPERATION.....</b>	<b>13–14</b>
■ Scan types .....	13
■ Setting Tag channels .....	14
■ Starting a scan .....	14
<b>6 DUALWATCH and TRI-WATCH.....</b>	<b>15</b>
■ About Dualwatch and Tri-watch .....	15
■ Operation .....	15
<b>7 LAND CHANNEL OPERATION .....</b>	<b>16</b>
■ LAND Channel Group .....	16
■ Function display .....	16

---

## TABLE OF CONTENTS (Continued)

---

<b>8 SET MODE</b> .....	<b>17–21</b>		
■ Set mode setting .....	17		
◇ Set mode operation.....	17		
■ Set mode items .....	18		
◇ Beep Tone function “bP”.....	18		
◇ Weather Alert function “AL”.....	18		
◇ Priority Scan function “Pr”.....	18		
◇ Scan Resume timer “St”.....	18		
◇ Auto Scan function “AS”.....	19		
◇ Dualwatch or Tri-watch function “dt”.....	19		
◇ Monitor Key Action “Sq”.....	19		
◇ Automatic Backlighting “bL”.....	19		
◇ LCD Contrast “LC”.....	20		
◇ Auto Power Save function “PS”.....	20		
◇ Self Check function “SC”.....	20		
◇ Battery Voltage indicator “bt”.....	21		
<b>9 BATTERY CHARGING</b> .....	<b>22–27</b>		
■ Caution.....	22		
◇ Battery caution.....	22		
◇ Charging caution.....	24		
■ Supplied battery charger.....	24		
◇ Charging connections.....	24		
◇ For your convenience.....	25		
■ Optional battery chargers.....	26		
◇ Rapid charging with the BC-190.....	26		
◇ Rapid charging with the BC-197.....	27		
<b>10 SPEAKER-MICROPHONE</b> .....	<b>28</b>		
■ HM-168IS Description.....	28		
■ Attachments.....	28		
<b>11 TROUBLESHOOTING</b> .....	<b>29</b>		
<b>12 VHF MARINE CHANNEL LIST</b> .....	<b>30</b>		
<b>13 SPECIFICATIONS</b> .....	<b>31</b>		
◇ GENERAL.....	31		
◇ TRANSMITTER.....	31		
◇ RECEIVER.....	31		
◇ BATTERY PACK.....	32		
◇ CHARGER.....	32		
◇ DC CABLES.....	32		
◇ OTHER OPTIONS.....	32		
<b>14 OPTIONS</b> .....	<b>32</b>		
<b>15 QUICK REFERENCE</b> .....	<b>33</b>		
<b>16 INFORMATION</b> .....	<b>35</b>		
■ UL information.....	35		
<b>INDEX</b> .....	<b>36</b>		



## ◇ **Priorities**

- Read all rules and regulations pertaining to priorities and keep an up-to-date copy handy. Safety and distress calls take priority over all others.
- You must monitor Channel 16 when you are not operating on another channel.
- False or fraudulent distress calls are prohibited under law.

## ◇ **Privacy**

- Information overheard but not intended for you cannot lawfully be used in any way.
- Indecent or profane language is prohibited.

## ◇ **Radio licenses**

### **(1) SHIP STATION LICENSE**

When your craft is equipped with a VHF FM transceiver, you must have a current radio station license before using the transceiver. It is unlawful to operate a ship station which is not licensed.

Inquire through your dealer or the appropriate government agency for a Ship-Radiotelephone license. This license includes the call sign which is your craft's identification for radio purposes.

### **(2) OPERATOR'S LICENSE**

A restricted Radiotelephone Operator Permit is the license most often held by small vessel radio operators when a radio is not required for safety purposes.

The Restricted Radiotelephone Operator Permit must be posted near the transceiver or be kept with the operator. Only a licensed radio operator may operate a transceiver.

However, non-licensed individuals may talk over a transceiver if a licensed operator starts, supervises, ends the call and makes the necessary log entries.

A current copy of the applicable government rules and regulations is only required to be on hand for vessels in which a radio telephone is compulsory. However, even if you are not required to have these on hand it is your responsibility to be thoroughly acquainted with all pertinent rules and regulations.

**NOTE:** Even though the IC-M88 is capable of operation on VHF marine channels 3, 21, 23, 61, 64, 81, 82 and 83, according to FCC regulations these simplex channels cannot be lawfully used by the general public in USA waters.

## ■ Supplied accessories

The following accessories are supplied:

	Qty.
• Swivel belt clip.....	1
• Stopper for the swivel belt clip.....	1
• Screws for the swivel belt clip.....	2
• Flexible antenna.....	1
• Handstrap.....	1
• Battery pack.....	1
• Power adapter.....	1
• Battery charger.....	1

## ■ Attachments

### ◇ Swivel belt clip

To attach:

- ① Attach the stopper to the back of the transceiver.

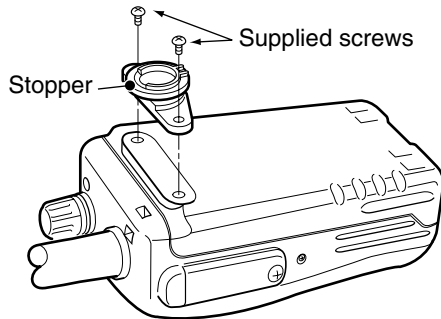

- ② Clip the belt clip to a part of your belt and insert the stopper to the belt clip.

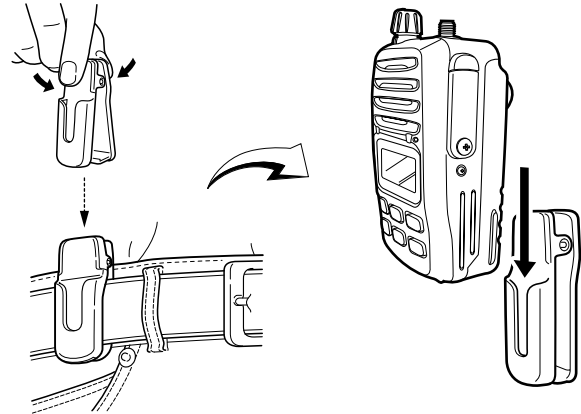

- ③ Once the transceiver is locked in place, it will swivel 360 degrees.

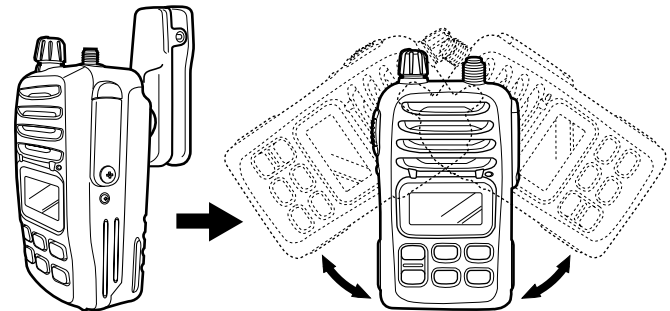

**To remove:**

Turn the transceiver upside down, and then lift up to release the transceiver from the belt clip.

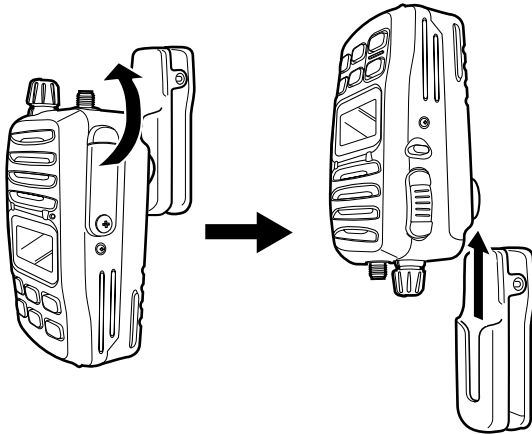

**CAUTION:**  
**HOLD THE TRANSCEIVER TIGHTLY, WHEN ATTACHING OR REMOVING THE TRANSCEIVER FROM THE BELT CLIP.**

If the transceiver is accidentally dropped and the swivel belt clip's stopper is scratched or damaged, the swivel belt clip may not work properly.

◇ **Flexible antenna**

Connect the supplied flexible antenna to the antenna connector.

**CAUTION:**

- **NEVER** carry the transceiver by holding only the antenna.
- **DO NOT** connect the antenna other than the supplied one.
- Transmitting without an antenna will damage the transceiver.

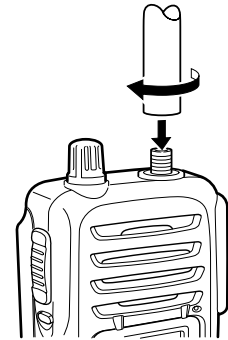

◇ **Handstrap**

Pass the handstrap through the loop on the back side of the transceiver as illustrated at right. This facilitates carrying.

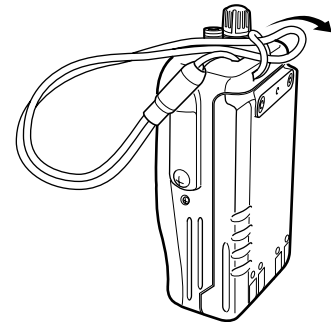

# 3

## PANEL DESCRIPTION

### ■ Front, top and side panels

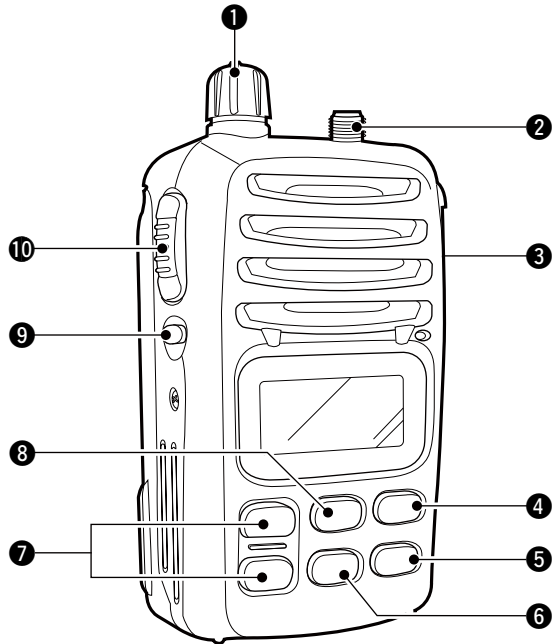

#### ❶ VOLUME CONTROL [VOL]

Push to turn ON the power and adjusts the audio level.

#### ❷ ANTENNA CONNECTOR (p. 3)

Connects the supplied antenna.

#### ❸ SPEAKER-MICROPHONE CONNECTOR [SP MIC]

(p. 28)

Connects the optional speaker-microphone.

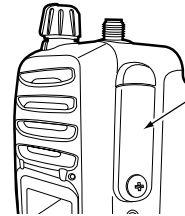

[SP MIC] jack cover

**NOTE:** KEEP the [SP MIC] jack cover attached to the transceiver when the speaker-microphone is not in use.

#### ❹ SCAN KEY [SCAN•DUAL] (pp. 14, 15)

- Push to start or stop the Normal or Priority scan.
- Hold down for 1 second to start Dualwatch or Tri-watch.

#### ❺ TRANSMIT POWER/LOCK KEY [H/L•LOCK]

- Push to select the High, Mid or Low power level. (p. 10)
- Hold down for 1 second to turn the Lock function ON or OFF. (p. 12)

#### ❻ CHANNEL 16 KEY [16•9]

- Push to select Channel 16. (p. 8)
- Hold down for 1 second to select the Call channel. (p. 8)
- When the Call channel is selected, hold down for 3 seconds to enter the Call channel entry mode. (p. 12)

**7 CHANNEL UP/DOWN KEYS [▲]/[▼]**

- Push to select an operating channel. (p. 9)
- Push to select the Set mode item option. (p. 17)
- Push to check Tag channels, or change scanning direction during a scan. (p. 14)
- Hold down both keys for 1 second to set or clear the displayed channel as a Tag (scanned) channel.
- While holding down this key, turn ON the power to clear all Tag channels in the selected channel group.

**8 CHANNEL/WEATHER CHANNEL KEY [CH/WX•U/I/C/L]**

- Push to toggle the regular channels and Weather channel group. (pp. 8, 9, 16)
- Hold down for 1 second to sequentially select one of 4 regular channels. (pp. 9, 16)
  - USA, International, Canadian and Land channels are selectable.
- Push to return to the mode before selecting the channel when the Priority channel or the Call channel is selected.

**9 SQUELCH KEY [SQL] (p. 11)**

- Push this key, then set the squelch level with [▲]/[▼].
- While holding down this key, you can manually open the squelch to monitor the channel.
- While holding down this key, turn ON the power to enter the Set mode.

**10 PTT SWITCH [PTT]**

Hold down to transmit, release to receive.

**◇ Battery pack release button**

**To remove the battery pack:**

Push the battery release button in the direction of the arrow (❶) as shown below. The battery pack can then be removed.

**To attach the battery pack:**

Slide the battery pack on the back of the transceiver in the direction of the arrow (❷), then lock it with the battery release button.

- Slide the battery pack until the battery release button makes a ‘click’ sound.

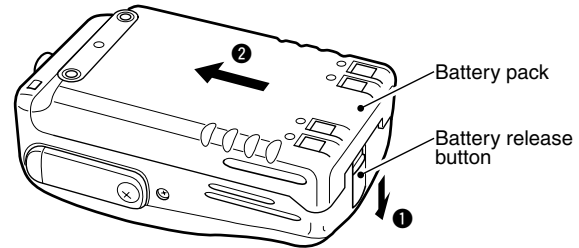

**CAUTION:** When pushing the battery release button, slide the battery pack slightly in the direction of the arrow (❷) to ease release. This will prevent possible injuring your fingers or nails.

**NOTE:** Keep the battery pack terminals clean. It's a good idea to occasionally clean them.

**NEVER** remove or attach the battery pack when the transceiver is wet or soiled. This may result water or dust getting into the transceiver/battery pack and may result in damaging the transceiver.

### 3 PANEL DESCRIPTION

#### ■ Function display

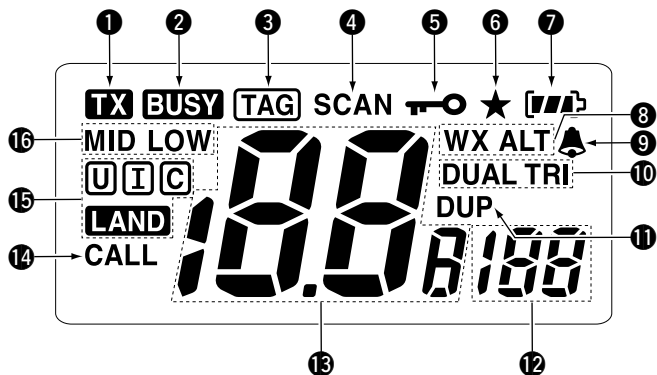

- ❶ **TRANSMIT ICON** (p. 10)  
Displayed while transmitting.
- ❷ **BUSY ICON** (p. 10)
  - Displayed when receiving a signal or when the squelch opens.
  - Blinks while monitoring.
- ❸ **TAG CHANNEL ICON** (p. 14)  
Displayed when a Tag channel is selected.
- ❹ **SCAN ICON** (p. 14)  
Blinks while scanning.
- ❺ **LOCK ICON** (p. 12)  
Displayed while the lock function is activated.
- ❻ **NARROW ICON** (p. 16)  
Displayed when narrow channel spacing is selected.  
(Only LAND channel group)
- ❼ **BATTERY ICON**  
Displays remaining battery capacity.

Indication				
Battery status	Full	Mid	Charging required	Exhausted

blinks when the battery is over charged.

**8 WEATHER CHANNEL/WEATHER ALERT ICONS**

- “WX” is displayed when the Weather channel group is selected. (p. 9)
- “ALT” is displayed while the Weather Alert function is activated.

**9 BELL ICON**

Blinks when an Alert tone is received.

**10 DUALWATCH/TRI-WATCH ICONS** (p. 15)

- “DUAL” is displayed during Dualwatch.
- “TRI” is displayed during Tri-watch.

**11 DUPLEX ICON**

Displayed when a Duplex channel is selected.

**12 SUB CHANNEL READOUT**

- Displays Channel 16 during Priority scan, Dualwatch or Tri-watch. (p. 15)
- In the Set mode, displays the selected Set mode item.

**13 CHANNEL NUMBER READOUT**

- Displays the selected operating channel number.
- In the Set mode, displays the selected condition.

**14 CALL CHANNEL ICON** (p. 8)

Displayed when the Call channel is selected.

**15 CHANNEL GROUP ICON** (pp. 9, 16)

- “U” is displayed when the USA channel group is selected.
- “I” is displayed when the International channel group is selected.
- “C” is displayed when the Canadian channel group is selected.
- “LAND” is displayed when the LAND channel group is selected.

**16 TRANSMIT POWER ICON** (p. 10)

- “LOW” is displayed when Low power is selected.
- “MID” is displayed when Mid power is selected.
- No indication is displayed when High power is selected.

## ■ Selecting a Channel

**IMPORTANT:** Prior to using the transceiver for the first time, the battery pack must be fully charged for optimum life and operation. To avoid damage to the transceiver, turn OFF the power while charging.

### ◇ Channel 16

Channel 16 (Distress channel) is used to establish the initial contact with another station, and for emergency communications. Channel 16 is automatically monitored during both Dualwatch and Tri-watch. While standing by, you must monitor Channel 16.

- ① Push [16•9] to select Channel 16.
- ② Push [CH/WX•U/I/C/L] to return to the mode before selecting Channel 16, or push [▲] or [▼] to select the operating channel.



### ◇ Channel 9 (Call channel)

Channel 9 is the leisure-use Call channel. Each regular channel group has separate Call channels. In addition, each Call channel is monitored during Tri-watch. The Call channels can be set (p. 12) and are used to store your most often-used channels in each channel group for quick recall.

- ① Hold down [16•9] for 1 second to select the Call channel in the selected channel group.
  - “CALL” and the Call channel number appear.
  - Each channel group may have its own Call channel after setting it. See “Setting the Call channel” on page 12 for details.
- ② Push [CH/WX•U/I/C/L] to return to the mode before selecting Channel 9 (Call channel), or push [▲] or [▼] to select the operating channel.

Hold down



for 1 second





◇ **USA, International and Canadian channels**

There are 57 USA, 57 International, and 61 Canadian channels. Choose the appropriate channel group for your operating area, and then select a desired channel.

- ① Push [CH/WX•U/I/C/L] to select a regular channel.
  - If a Weather channel appears, push [CH/WX•U/I/C/L] again.
- ② Push [▲] or [▼] to select a channel.
  - “DUP” appears for duplex channels.
- ③ To change the channel group, hold down [CH/WX•U/I/C/L] for 1 second.
  - USA, International and Canadian channels can be sequentially selected. Depending on the setting, LAND channel can be selected. See “LAND CHANNEL OPERATION” on page 16 for details.

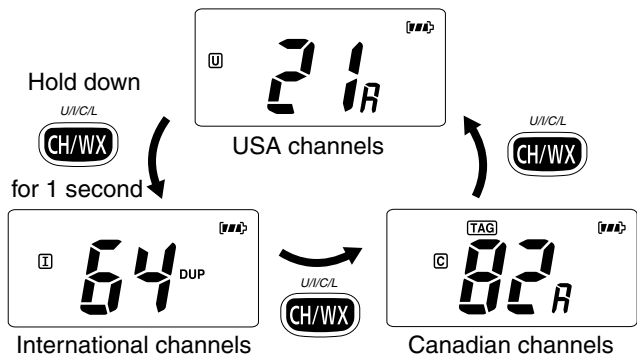

◇ **Weather channels** (Available for USA version only)

There are 10 Weather channels. They are used for monitoring Weather channels from the NOAA (National Oceanographic and Atmospheric Administration) broadcasts.

- ① Push [CH/WX•U/I/C/L] to select the Weather channel group.
- ② Push [▲] or [▼] to select a Weather channel.
- ③ Push [CH/WX•U/I/C/L] to return to the mode before selecting the Weather channel group.

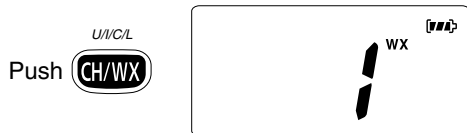

**For your convenience:** The IC-M88 can detect a Weather alert tone on the selected Weather channel while receiving on another channel or during a scan. See the “Set mode items” on page 18 for details.

## 4 BASIC OPERATION

### ■ Receiving and transmitting

**CAUTION:** Transmitting without an antenna will damage the transceiver.

- ① Rotate [VOL] clockwise to turn ON the power.
- ② Use the squelch function to mute any audio noise if necessary. After holding down [SQL] for 1 second, the squelch function is cut off until [SQL] is released. (default)
- ③ Hold down [SQL] for 1 second (see “Set mode” on page 19), and rotate volume to set the volume level.
- ④ Push [▲] or [▼] to select a channel.
  - While receiving a signal, “**BUSY**” appears and audio is heard from the speaker.
  - Further adjustment of [VOL] may be necessary at this point.
- ⑤ Push [H/L•LOCK] to select the output power if necessary.
  - “LOW” is displayed when low power is selected, “MID” is displayed when middle power is selected, No indication is displayed when high power is selected.
  - Choose Low power to conserve the battery power, choose High power for long range communications.
  - Some channels are restricted to Low power only.
- ⑥ Hold down [PTT] to transmit, then speak into the microphone.
  - “TX” appears.
  - You cannot transmit on Channel 70.
- ⑦ Release [PTT] to receive.

**IMPORTANT:** To maximize the readability of your transmitted signal, pause a few second after holding down [PTT], hold the microphone 5 to 10 cm (2 to 4 inches) from your mouth and speak at your normal voice level.

**NOTE:** The transceiver has a Power Save function to conserve the battery power and it cannot be turned OFF. The Power Save function automatically activates when no signal is received for 5 seconds.

**For USA version:** To prevent accidental prolonged transmission, the IC-M88 has a time-out timer function. This timer cuts the transmission OFF after 5 minutes of continuous transmission.

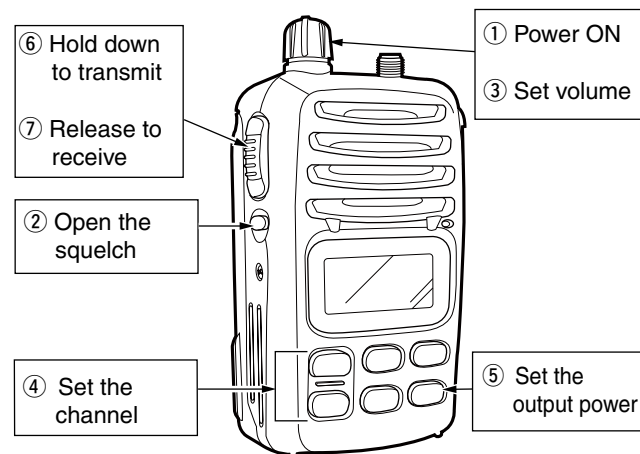

## ■ Adjusting the squelch level

The IC-M88 has a squelch circuitry. In order to receive the signals properly, as well as for the efficient scan, the squelch must be adjusted to the proper level.

- ① Push [SQL], then adjust the squelch level with [▲]/[▼].
  - “SL” indicator is displayed.
  - There are 11 squelch levels. OP is completely open, 10 is the tightest squelch level.
  - When no key is pushed for 5 seconds, the transceiver returns to the normal condition.
- ② Push [SQL] again to return to the normal condition.

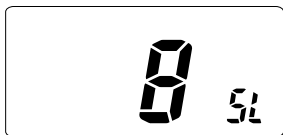

## ■ Automatic backlight

This function is convenient for nighttime operation. The automatic backlight can be activated in the Set mode. (p. 19)

- Push any key except [PTT] to turn ON the backlight.
  - The backlight is automatically turned OFF after 5 seconds of inactivity.

## ■ Lock function

This function electronically locks all keys (except for [PTT], [SQL] and [H/L•LOCK]) to prevent accidental channel changes and function access.

- Hold down [H/L•LOCK] for 1 second to turn the lock function ON and OFF.



Displayed when the Lock function is ON.

## 4 BASIC OPERATION

### ■ Setting the Call channel

The Call channel key is used to select Channel 9 by default, however, you can set your most often-used channels in each channel group for quick recall.

- ① Hold down [CH/WX•U/I/C/L] for 1 second several times to select the desired channel group (USA, INT, CAN) to be used.



- ② Hold down [16•9] for 1 second to select the Call channel.  
• "CALL" and Call channel number appear.



- ③ Hold down [16•9] again for 3 seconds (until a long beep changes to 2 short beeps) to enter Call channel programming condition.  
• Call channel number to be programmed flashes.

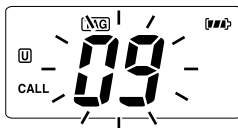

- ④ Push [▲] or [▼] to select the desired channel.

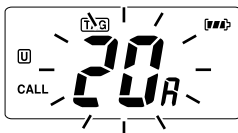

- ⑤ Push [16•9] to program the displayed channel as the Call channel.  
• The Call channel number stops blinking.



## ■ Scan types

Scanning is an efficient way to locate signals quickly over a wide frequency range. The transceiver has a Priority scan and a Normal scan.

In addition, the Weather alert and Auto scan functions can be selected in standby. These functions can be activated simultaneously, depending on the settings in the Set mode. (pp. 18, 19)

Set the Tag channels (scanned channel) before scanning. Clear the Tag channels that inconveniently stop scanning, such as digital communications.

▨ Choose the Priority or Normal scan in the Set mode. (p. 18)

4

5

### PRIORITY SCAN

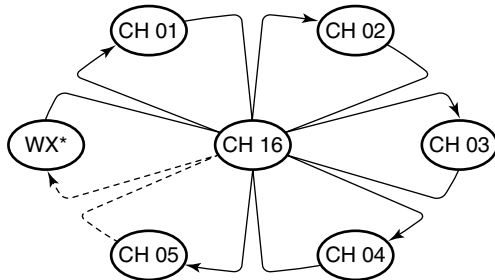

\* Previously selected Weather channel when weather alert function is ON

The Priority scan searches through all Tag channels in sequence while monitoring Channel 16. When a signal is detected on Channel 16, the scan pauses until the signal disappears. When a signal is detected on a channel other than Channel 16, the scan becomes Dualwatch until the signal disappears.

### NORMAL SCAN

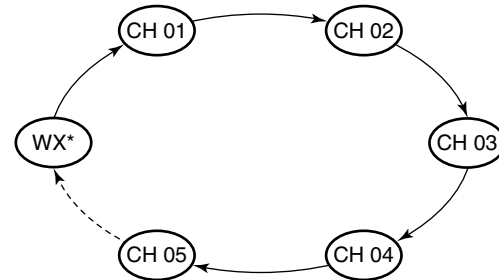

\* Previously selected Weather channel when weather alert function is ON

The Normal scan, like the Priority scan, searches through all Tag channels in sequence. However, unlike the Priority scan, Channel 16 is not checked unless Channel 16 is set as a Tag channel.

## 5 SCAN OPERATION

### ■ Setting Tag channels

For more efficient scanning, add desired channels as Tag channels or clear unwanted channels as Tag channels. Non-Tag channels are skipped during scanning. Tag channels can be assigned to each channel group (USA, INT, CAN) independently.

- ① Hold down [CH/WX•U/I/C/L] for 1 second to select the desired channel group (USA, INT, CAN).
- ② Select the desired channel to set as a Tag channel.
- ③ Hold down both [▲] and [▼] for 1 second to set the displayed channel as a Tag channel.
  - “TAG” is displayed in the function display.
- ④ Hold down both [▲] and [▼] for 1 second again to cancel the Tag channel setting.
  - “TAG” disappears.

#### • Clearing all Tag channels in the selected channel group

Turn OFF the power, then while holding down both [▲] and [▼], turn ON the power to clear all Tag channels in the selected channel group.

### ■ Starting a scan

First set the Weather Alert function, Priority Scan function, Scan Resume timer, and Auto Scan function in the Set mode. (pp. 18, 19)

- ① Hold down [CH/WX•U/I/C/L] for 1 second to select the desired channel group (USA, INT, CAN).
  - When the Weather Alert function is in use, select the desired Weather channel with [CH/WX•U/I/C/L] and [▲]/[▼].
- ② Push [SCAN•DUAL] to start a Priority or Normal scan.
  - “SCAN” blinks in the function display.
  - “16” is displayed during a Priority scan.
  - When a signal is received, scan pauses until the signal disappears, or resumes after pausing 5 seconds according to Set mode setting. (Channel 16 is still monitored during Priority scan.)
  - Push [▲] or [▼] to check the scanning Tag channels, to change the scanning direction or to manually resume the scan.
- ③ Push [SCAN•DUAL] to stop the scan.
  - “SCAN” disappears.
  - Pushing [PTT], [16•9] or [CH/WX•U/I/C/L] also stops the scan.

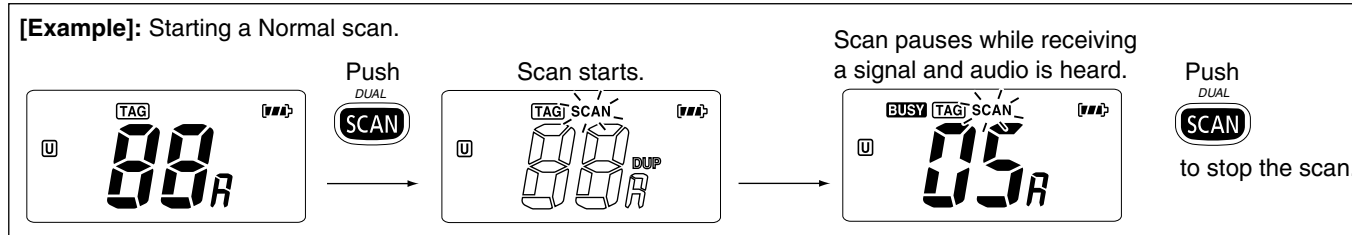

## About Dualwatch and Tri-watch

Dualwatch monitors Channel 16 while receiving another channel.

Tri-watch monitors Channel 16 and the Call channel while receiving another channel.

### DUALWATCH/TRI-WATCH SIMULATION

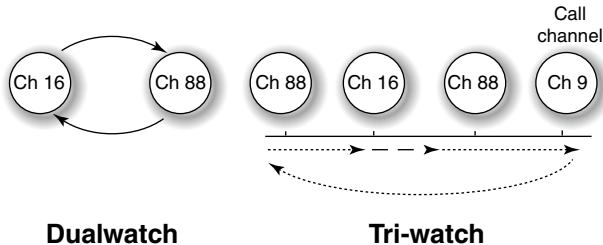

- If a signal is received on Channel 16, Dualwatch or Tri-watch pauses on Channel 16 until the signal disappears.
- If a signal is received on the Call channel during Tri-watch, Tri-watch becomes Dualwatch until the signal disappears.
- To transmit on the selected channel during Dualwatch or Tri-watch, hold down [PTT].

## Operation

- ① Select the desired operating channel.
- ② Hold down [SCAN•DUAL] for 1 second to start Dualwatch or Tri-watch (depending on Set mode setting).
  - “DUAL” blinks during Dualwatch, “TRI” blinks during Tri-watch.
  - A beep tone sounds when a signal is received on Channel 16.
  - Tri-watch becomes Dualwatch when receiving a signal on the Call channel.
- ③ Push [SCAN•DUAL] to cancel Dualwatch or Tri-watch.

**[Example]:** Operating Tri-watch on INT channel 07.

Hold down



for 1 second.



Tri-watch starts.



Signal is received on Call channel.



Signal received on Channel 16 takes priority.



Tri-watch resumes after the signal disappears.

## ■ LAND Channel Group

A maximum of 22 free LAND mobile channels (allocated between 146.000 and 174.000 MHz) can be programmed into the LAND channel group for simple communication with LMR transceivers in the VHF band.

Moreover, any of the marine channels in the USA, INT and CAN channel groups can be programmed.

The default setting of the LAND channel group is the same as that of the INT channel group. Ask your local Icom dealer for the LAND channel group setting and LMR frequency programming details.

- ① Push [CH/WX•U/I/C/L] to select a regular channel.
  - If a Weather channel is displayed, push [CH/WX•U/I/C/L] again.
- ② Hold down [CH/WX•U/I/C/L] for 1 second several times to change the channel group.
  - “LAND” is displayed when LAND channel group is selected.
- ③ Push [▲] or [▼] to select a channel.
  - “DUP” is displayed when Duplex channels is selected.

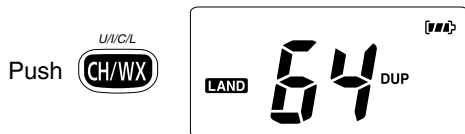

**NOTE:** The basic settings (example: Setting the Call channel) are same as the USA, International and Canadian channels. Refer to the appropriate pages for details.

## ■ Function display

When Narrow, DTCS or CTCSS is set, the icon is displayed as shown below.

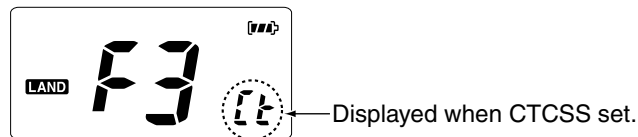
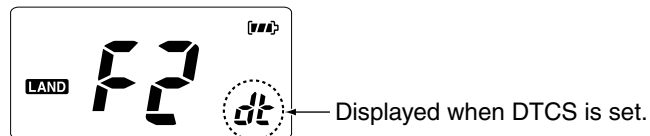
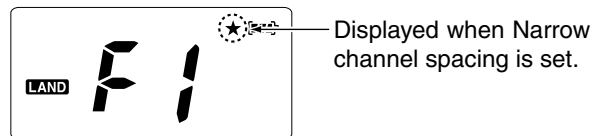



## ■ Set mode setting

The Set mode is used to change the condition of 13 transmitter functions: Beep Tone function, Weather Alert function, Priority Scan function, Scan Resume timer, Auto Scan function, Monitor Key Action, Automatic Backlighting, LCD Contrast selection, Auto Power Save function, Self Check function, and Battery Voltage indicator.

### ◇ Set mode operation

- ① Turn OFF the power.
- ② While holding down [SQL], turn ON the power to enter the Set mode.
  - “bp” is displayed.
- ③ Push [SQL] to select the desired item, if necessary.
- ④ Push [▲] or [▼] to select the desired item option.
- ⑤ To exit Set mode, push [16•9].

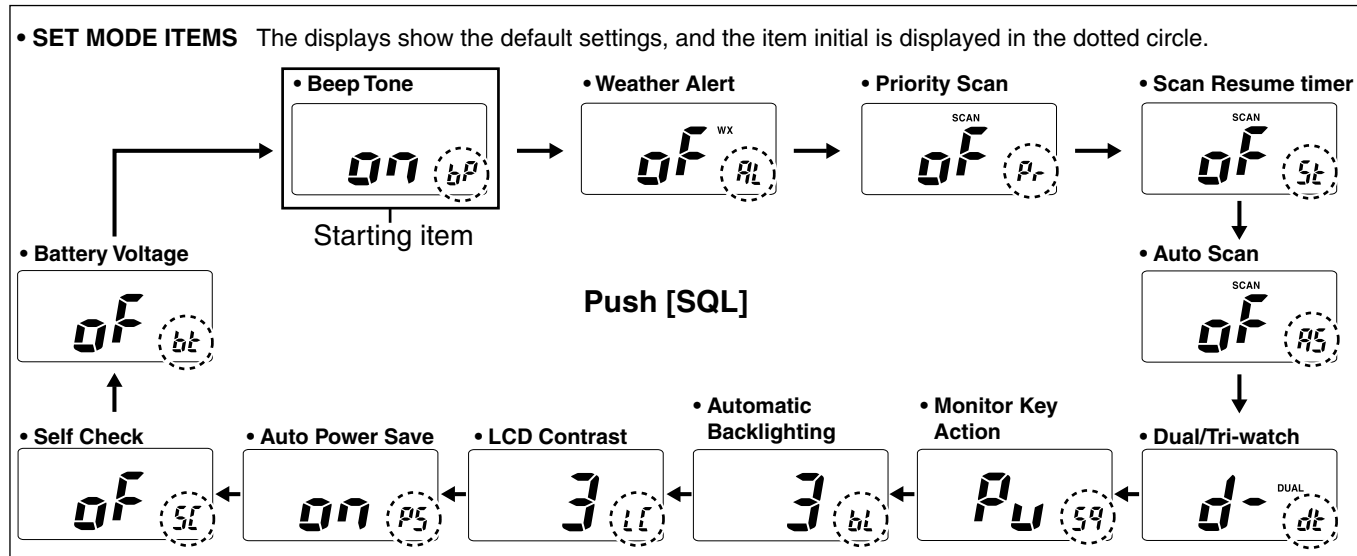

## ■ Set mode items

### ◇ Beep Tone function “bP”

You can select silent operation by turning OFF the beep tones, or you can have 2 types of confirmation beeps sound at the push of a key. When ON is selected, a fixed beep (Pi) sounds and when US is selected, the preset beeps (example: do, re, mi) sound.



Beep tone ON (default)



User Beep

### ◇ Weather Alert function “AL”

A NOAA broadcast station transmits a Weather alert tone before any important Weather announcements. When the Weather Alert function is turned ON, the transceiver detects the alert, the bell icon blinks and sounds a beep tone until you operate the transceiver. The previously selected (used) Weather channel is checked any time during standby, or while scanning, when the Power Save function is activated.

• “AL” appears when the function is set ON.

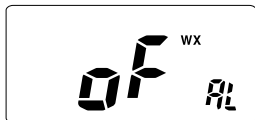

Weather Alert function OFF (default)

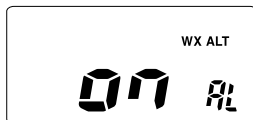

Weather Alert function ON

### ◇ Priority Scan function “Pr”

The transceiver has 2 scan types— Normal and Priority scans.

A Normal scan searches all Tag channels in the selected channel group.

Priority scan sequentially searches all Tag channels while monitoring Channel 16.

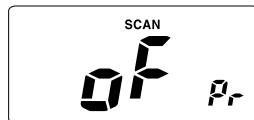

Normal scan (default)



Priority scan

### ◇ Scan Resume timer “St”

You can set the Scan Resume timer as a pause (OFF) or timer scan (ON). When OFF is selected, the scan pauses until a received signal disappears. When ON is selected, the scan pauses for 5 seconds after receiving a signal and then resumes, even if a signal has been received.



Scan resume timer OFF (default)

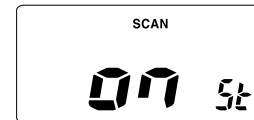

Scan resume timer ON

### ◇ Auto Scan function “AS”

The Auto Scan function automatically starts the desired scan when no signal is received, or no operation is performed for 30 seconds.



Auto scan OFF (default)

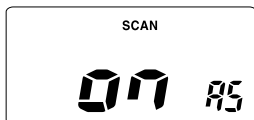

Auto scan ON

### ◇ Dualwatch or Tri-watch function “dt”

This item selects Dualwatch or Tri-watch as desired. See page 15 for details.

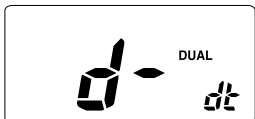

Dualwatch function  
(default)

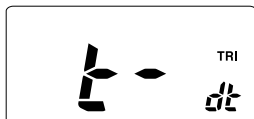

Tri-watch function

### ◇ Monitor Key Action “Sq”

The Monitor Key Action temporarily cuts off the squelch function.

- Pu (PUSH): After holding down [SQL] for 1 second, the squelch opens, and audio sounds while holding down [SQL]. (default)
- Ho (HOLD): After holding down [SQL] for 1 second, the squelch opens, and audio sounds even when [SQL] is released. To close the squelch, push any key.



Monitor Key Action  
PUSH (default)



Monitor Key Action  
Hold

### ◇ Automatic Backlighting “bl”

This function is convenient for nighttime operation.

You can adjust the backlight level from OFF, 1 (dark) to 3 (bright). Select 1 to 3 to turn ON this function. (Default: 3)

- The automatic backlighting turns ON the backlighting when any key except for [PTT] is pushed.
- The backlighting is automatically turned OFF after 5 seconds of inactivity.



Automatic backlighting  
(default)



Automatic backlighting  
OFF

## 8 SET MODE

### ◇ LCD Contrast “LC”

You can select the LCD contrast from 4 levels.

- 1 (bright) ~ 4 (dark), 3 (default)



LCD contrast 3 (default)



LCD contrast 1

### ◇ Auto Power Save function “PS”

The Auto Power Save function reduces current drain by deactivating the receiver circuit for preset intervals.

- OFF: The Power Save function is turned OFF.
- ON: The Power Save function is turned ON. The Power Save function will be activated when no signal is received, and no operation is performed for 5 seconds.



Auto Power Save ON (default)



Auto Power Save OFF

### ◇ Self Check function “SC”

The Self Check function checks transceiver conditions by itself, and informs you in case a problem is found. The following items are checked after the power is turned ON, then it switches to the operation mode.

- Temperature : Outside of  $-35^{\circ}\text{C} \sim +73^{\circ}\text{C}$  ( $-31^{\circ}\text{F} \sim +163^{\circ}\text{F}$ ) (approximately)
- Battery voltage
- Water intrusion



Self check OFF (default)



Self check ON

When error messages are displayed as shown below, see trouble shooting for advice. (p. 29)

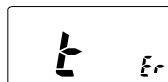

Temperature error



Battery voltage error



Water intrusion error

### ◇ Battery Voltage indicator “bt”

Select whether or not to display the connected battery pack's voltage at power ON.

- The battery pack's voltage is displayed for 2 seconds at power ON.



Battery voltage OFF  
(default)

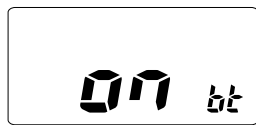

Battery voltage ON

### SET MODE LIST

Function	Indication	Options
Beep Tone function	"bP"	OFF / ON* / US
Weather Alert function	"AL"	OFF* / ON
Priority Scan function	"Pr"	OFF* / ON
Scan Resume timer	"St"	OFF* / ON
Auto Scan function	"AS"	OFF* / ON
Dual/Tri-watch function	"dt"	Dual* / Tri
Monitor Key Action	"Sq"	Push* / Hold
Automatic Backlighting	"bL"	OFF / 1 / 2 / 3*
LCD Contrast selection	"LC"	1 / 2 / 3* / 4
Auto Power Save function	"PS"	OFF / ON*
Self Check function	"SC"	OFF* / ON
Battery Voltage indicator	"bt"	OFF* / ON

\* default setting

## ■ Caution

Misuse of Li-ion batteries may result in the following hazards: smoke, fire, or the battery pack may rupture. Misuse can also cause damage to the battery pack or degradation of battery performance.

### ◇ Battery caution

⚠ **DANGER! DO NOT** strike or otherwise impact the battery pack. Do not use the battery pack if it has been severely impacted or dropped, or if it has been subjected to heavy pressure. The damage may not be visible on the outside of the case. Even if the surface of the battery pack does not show cracks or any other damage, the cells inside may rupture or catch fire.

⚠ **DANGER! NEVER** use the transceiver or the battery if either one is damaged, shows cracks, bruises or is deformed.

⚠ **DANGER! NEVER** place or leave the battery pack in areas with temperatures: Above +60°C (+140°F)

High temperature buildup in the battery pack, such as could occur near fires or stoves, inside a sun-heated vehicle, or in direct sunlight for long periods of time may cause the battery pack to rupture or catch fire. Excessive temperatures may also degrade performance or shorten battery life.

⚠ **DANGER! DO NOT** expose the battery pack to rain, snow, seawater, or any other liquids. Do not charge or use a wet battery pack. If the battery pack gets wet, be sure to wipe it dry before using.

⚠ **DANGER! KEEP** the battery pack away from fire. Fire or heat may cause them to rupture or explode. Dispose of an used battery pack in accordance with local regulations.

⚠ **DANGER! NEVER** solder the battery pack terminals, or modify the battery pack. This may generate heat in the battery, and the battery pack may burst, emit smoke or catch fire.

⚠ **DANGER!** Use the battery pack only with the transceiver for which it is specified. Never use a battery pack with any other equipment, or for any purpose that is not specified in this sheet.

⚠ **DANGER!** If fluid from inside the battery pack gets in your eyes, blindness can result. Rinse your eyes with clean water, without rubbing them, and see a doctor immediately.

⚠ **WARNING!** Immediately stop using the battery pack if it emits an abnormal odor, heats up, or is discolored or deformed. If any of these conditions occur, contact your Icom dealer or distributor.

⚠ **WARNING!** Immediately wash, using clean water, any part of the body that comes into contact with fluid from inside the battery pack.

⚠ **WARNING! NEVER** put the battery pack in a microwave oven, high-pressure container, or in an induction heating cooker. This could cause a fire, overheating, or cause the battery pack to rupture.

**CAUTION:** Always use the battery within the specified temperature range for the transceiver and the battery itself as shown below.

<Transceiver>

- Marine:  $-20^{\circ}\text{C} \sim +60^{\circ}\text{C}$  ( $-4^{\circ}\text{F} \sim +140^{\circ}\text{F}$ )
- LMR:  $-30^{\circ}\text{C} \sim +60^{\circ}\text{C}$  ( $-22^{\circ}\text{F} \sim +140^{\circ}\text{F}$ )

<Battery pack>

- BP-227UL :  $-10^{\circ}\text{C} \sim +60^{\circ}\text{C}$  ( $+14^{\circ}\text{F} \sim +140^{\circ}\text{F}$ )

Using the battery out of its specified temperature range will reduce the battery's performance and battery life. Please note that the specified temperature range of the battery may exceed that of the transceiver. In such cases, the transceiver may not work properly because it is out of its operating temperature range.

**CAUTION:** Shorter battery life could occur if the battery pack is left fully charged, completely discharged, or in an excessive temperature environment, as shown below, for an extended period of time.

- BP-227UL: Above  $+45^{\circ}\text{C}$  ( $+113^{\circ}\text{F}$ )

If the battery pack must be left unused for a long time, it must be detached from the transceiver after discharging. You may use the battery pack until the remaining capacity is about half, then keep it safely in a cool and dry place at the following temperature range:

- BP-227UL
  - $-20^{\circ}\text{C} \sim +45^{\circ}\text{C}$  ( $-4^{\circ}\text{F} \sim +113^{\circ}\text{F}$ ) (within a month)
  - $-20^{\circ}\text{C} \sim +40^{\circ}\text{C}$  ( $-4^{\circ}\text{F} \sim +104^{\circ}\text{F}$ ) (within 6 months)
  - $-20^{\circ}\text{C} \sim +35^{\circ}\text{C}$  ( $-4^{\circ}\text{F} \sim +95^{\circ}\text{F}$ ) (within a year)

**BE SURE** to replace the battery pack with a new one approximately five years after manufacturing, even if it still holds a charge. The inside battery material will become weak after a period of time, even with little use. The estimated number of times you can charge the battery is between 300 and 500. Even when the battery appears to be fully charged, the operating time of the transceiver may become short when:

- Approximately five years have passed since the battery was manufactured.
- The battery has been repeatedly charged.

## 9 BATTERY CHARGING

### ◇ Charging caution

⚠ **DANGER! NEVER** charge the battery pack in areas with extremely high temperatures, such as near fires or stoves, inside a sun-heated vehicle, or in direct sunlight. In such environments, the safety/protection circuit in the battery pack will activate, causing the battery to stop charging.

⚠ **WARNING! NEVER** charge the transceiver during a lightning storm. It may result in an electric shock, cause a fire or damage the transceiver. Always disconnect the power adapter before a storm.

⚠ **WARNING! NEVER** charge or leave the battery pack in the battery charger beyond the specified time for charging. If the battery pack is not completely charged by the specified time, stop charging and remove the battery pack from the battery charger. Continuing to charge the battery pack beyond the specified time limit may cause a fire, overheating, or the battery pack may rupture.

⚠ **WARNING! NEVER** insert the transceiver (the battery pack attached to the transceiver) into the charger if it is wet or soiled. This could corrode the battery charger terminals or damage the charger. The charger is not waterproof.

**CAUTION: DO NOT** charge the battery outside of the specified temperature range:

- BP-227UL: 0°C ~ +45°C (+32°F ~ +113°F)

Icom recommends charging the battery at +20°C (+68°F). The battery may heat up or rupture if charged out of the specified temperature range. Additionally, battery performance or battery life may be reduced.

## ■ Supplied battery charger

### ◇ Charging connections

- ① Attach the BC-152N to a flat surface, such as desk or cabin.
- ② Connect the power adapter, as shown to the right.
- ③ Insert the battery pack with or without the transceiver into the charger.
  - The charge indicator lights orange.
- ④ Charge the battery pack for approximately 10 hours, depending on the remaining power condition.
  - The charge indicator lights green when charging is completed.

### ○ Charging indicator:

- Lights orange while charging.
- Lights green after charging is completed.
- Blinks orange or green, or does not light when a problem is detected.

### ▨ SOLUTIONS:

- Remove the battery pack, and reinsert it.
- Remove the battery pack, clean the battery terminals, then reinsert it.
- If the battery pack temperature is high, remove and let it cool down, then reinsert it.

If you are unable to solve the problem through the use of these solutions, the battery pack or the charger may be damaged, or the battery life may be over. In that case, contact your near Icom Dealer or Service Center.



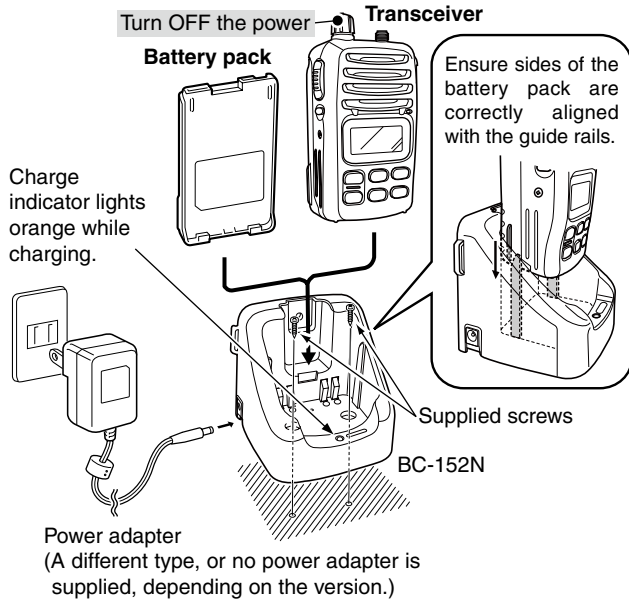

**NOTE:** Optional OPC-515L\* (for power source) or CP-23L (for 12 V cigarette lighter socket) can be used instead of the power adapter.

\*About OPC-515L  
White line: ⊕ Black line: ⊖

◇ **For your convenience**

**Eyelet**  
USE a rubber band to secure the transceiver while charging, if desired.

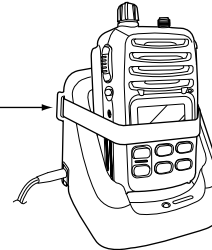

**NOTE:** After charging is completed, the BC-152N will automatically recharge the battery pack when the battery voltage decreases. If the battery pack is often left in the charger for long periods, the battery life cycle will be shorter.

## 9 BATTERY CHARGING

### ■ Optional battery chargers

#### ◇ Rapid charging with the BC-190

The optional BC-190 can rapidly charge battery packs.

- ① Attach the BC-190 to a flat surface, such as desk or cabin.
- ② Connect the power adapter, as shown to the right.
- ③ Insert the battery pack with or without the transceiver into the charger.
  - The charge indicator lights orange.
- ④ Charge the battery pack for approximately 2 ~ 2.5 hours, depending on the remaining power condition.
  - The charge indicator lights green when charging is completed.

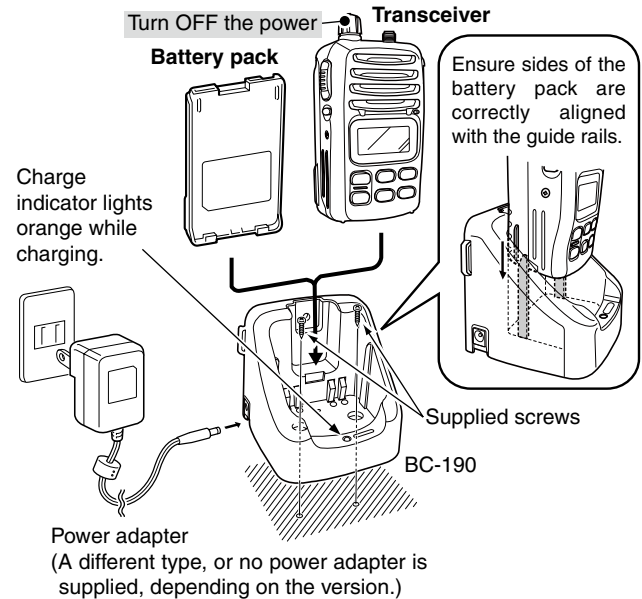

◇ **Rapid charging with the BC-197**

The optional BC-197 can simultaneously charge up to 6 battery packs.

The following items are additionally required.

- Six AD-128 charger adapters supplied with the BC-197.
- A power adapter (BC-157S) supplied with the BC-197, or the DC power cable OPC-656.

**IMPORTANT: Battery charging caution**  
 Ensure the guide tabs on the battery pack are correctly aligned with the guide rails inside the charger adapter. (This illustration is described with the BC-197.)

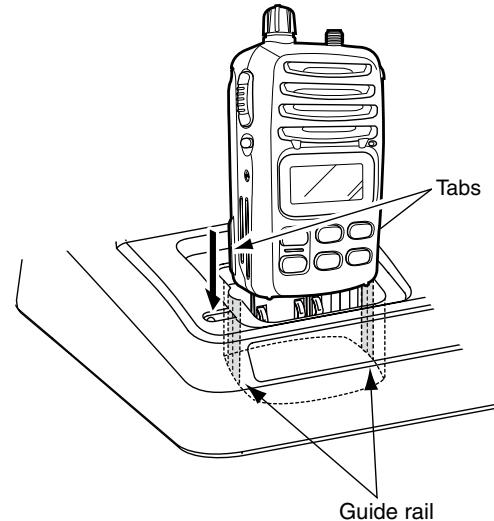
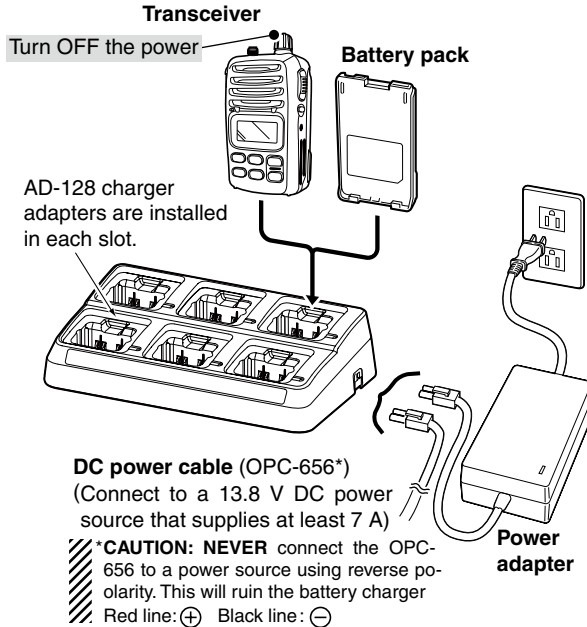

# 10 SPEAKER-MICROPHONE

## ■ HM-168IS Description

### Alligator type clip

To attach the speaker-mic.  
to your shirt or collar, and so on.

### PTT switch

Transmits while pushed  
Receives while released

### Microphone

### Speaker

Turn the transceiver power OFF  
when connecting the HM-168IS.

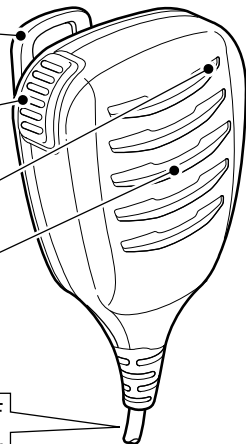

**NEVER** immerse the connector in water. If the connector becomes wet, be sure to dry it **BEFORE** attaching it to the transceiver.

**NOTE:** The microphone is located at the top of the speaker-microphone, as shown in the diagram above. To maximize the readability of your transmitted signal (voice), hold the microphone approximately 5 ~ 10 cm (2 ~ 4 inches) from your mouth, and speak in your normal voice level.

## ■ Attachments

Insert the connector of the speaker-microphone into the [SP MIC] connector on the transceiver and tighten the screw.

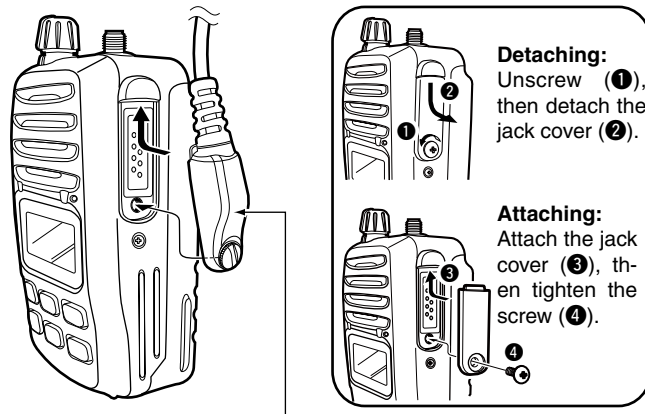

**CAUTION:** Attach the speaker-microphone's connector securely to prevent accidental dropping, or water intrusion in the connector.

**IMPORTANT: KEEP** the [SP MIC] jack cover attached (transceiver) when the speaker-microphone is not in use as illustrated above. Water will not get into the transceiver even if the cover is not attached, however, the terminals (pins) will become rusty, or the transceiver will function abnormally if the connector becomes wet.

# TROUBLESHOOTING 11

PROBLEM	POSSIBLE CAUSE	SOLUTION.	REF.
The transceiver does not turn ON.	<ul style="list-style-type: none"> <li>• The battery is exhausted.</li> <li>• Bad battery connection.</li> </ul>	<ul style="list-style-type: none"> <li>• Recharge the battery pack.</li> <li>• Remove and reattach the battery.</li> </ul>	p. 22 p. 5
No sound from speaker.	<ul style="list-style-type: none"> <li>• Squelch level is too deep.</li> <li>• Volume level is too low.</li> <li>• Speaker has been exposed to water.</li> </ul>	<ul style="list-style-type: none"> <li>• Set squelch to the threshold point.</li> <li>• Set [VOL] to a suitable level.</li> <li>• Drain water from the speaker.</li> </ul>	p. 11 p. 10 —
Transmitting is impossible, or high power can not be selected.	<ul style="list-style-type: none"> <li>• Some channels are for low power or receive only.</li> <li>• The battery is exhausted.</li> <li>• The output power is set to low.</li> </ul>	<ul style="list-style-type: none"> <li>• Change channels.</li> <li>• Recharge the battery pack.</li> <li>• Push [H/L•LOCK] to select high power.</li> </ul>	pp. 8, 9, 30 p. 22 p. 10
The displayed channel cannot be changed.	<ul style="list-style-type: none"> <li>• Lock function is activated.</li> </ul>	<ul style="list-style-type: none"> <li>• Hold down [H/L•LOCK] for 1 second to cancel the function.</li> </ul>	p. 12
Scan does not start.	<ul style="list-style-type: none"> <li>• “TAG” channels are not programmed.</li> </ul>	<ul style="list-style-type: none"> <li>• Set the desired channels as “TAG” channels.</li> </ul>	p. 14
No beeps.	<ul style="list-style-type: none"> <li>• Beep tones are turned OFF.</li> </ul>	<ul style="list-style-type: none"> <li>• Set the beep tones to ON (Fix Beep/User Beep) in Set mode.</li> </ul>	p. 18
Self check error. (Temperature)	<ul style="list-style-type: none"> <li>• The temperature is outside of <math>-35^{\circ}\text{C} \sim +73^{\circ}\text{C}</math> (<math>-31^{\circ}\text{F} \sim +163^{\circ}\text{F}</math>) (approximately)</li> </ul>	<ul style="list-style-type: none"> <li>• Leave the transceiver at room temperature for a while. Turn ON the power to check if the internal temperature has returned to normal.</li> </ul>	—
Self check error. (Battery voltage)	<ul style="list-style-type: none"> <li>• The connected battery pack’s voltage is more than 8.8 V.</li> </ul>	<ul style="list-style-type: none"> <li>• Verify the battery voltage is correct.</li> </ul>	—
Self check error. (Water intrusion)	<ul style="list-style-type: none"> <li>• Water has entered the transceiver.</li> </ul>	<ul style="list-style-type: none"> <li>• Have the transceiver checked at your local distributor or dealer to see whether the transceiver works properly or not.</li> </ul>	—

# 12 VHF MARINE CHANNEL LIST

Channel number			Frequency (MHz)	
USA	INT	CAN	Transmit	Receive
	01	01	156.050	160.650
01A			156.050	156.050
	02	02	156.100	160.700
	03	03	156.150	160.750
03A			156.150	156.150
	04		156.200	160.800
		04A	156.200	156.200
	05		156.250	160.850
05A		05A	156.250	156.250
06	06	06	156.300	156.300
	07		156.350	160.950
07A		07A	156.350	156.350
08	08	08	156.400	156.400
09	09	09	156.450	156.450
10	10	10	156.500	156.500
11	11	11	156.550	156.550
12	12	12	156.600	156.600
13*	13	13*	156.650	156.650
14	14	14	156.700	156.700
15*	15*	15*	156.750	156.750
16	16	16	156.800	156.800
17*	17	17*	156.850	156.850
	18		156.900	161.500
18A		18A	156.900	156.900
	19		156.950	161.550

\*Low power only.

Channel number			Frequency (MHz)	
USA	INT	CAN	Transmit	Receive
19A		19A	156.950	156.950
20	20	20*	157.000	161.600
20A			157.000	157.000
	21	21	157.050	161.650
21A		21A	157.050	157.050
	22		157.100	161.700
22A		22A	157.100	157.100
	23	23	157.150	161.750
23A			157.150	157.150
24	24	24	157.200	161.800
25	25	25	157.250	161.850
26	26	26	157.300	161.900
27	27	27	157.350	161.950
28	28	28	157.400	162.000
	60	60	156.025	160.625
	61		156.075	160.675
61A		61A	156.075	156.075
	62		156.125	160.725
		62A	156.125	156.125
	63		156.175	160.775
63A			156.175	156.175
	64	64	156.225	160.825
64A		64A	156.225	156.225
	65		156.275	160.875
65A	65A	65A	156.275	156.275

Channel number			Frequency (MHz)	
USA	INT	CAN	Transmit	Receive
	66		156.325	160.925
66A	66A	66A*	156.325	156.325
67*	67	67	156.375	156.375
68	68	68	156.425	156.425
69	69	69	156.475	156.475
70	70	70	Rx only	156.525
71	71	71	156.575	156.575
72	72	72	156.625	156.625
73	73	73	156.675	156.675
74	74	74	156.725	156.725
77*	77	77*	156.875	156.875
	78		156.925	161.525
78A		78A	156.925	156.925
	79		156.975	161.575
79A		79A	156.975	156.975
	80		157.025	161.625
80A		80A	157.025	157.025
	81		157.075	161.675
81A		81A	157.075	157.075
	82		157.125	161.725
82A		82A	157.125	157.125
	83	83	157.175	161.775
83A		83A	157.175	157.175
84	84	84	157.225	161.825
84A			157.225	157.225

Channel number			Frequency (MHz)	
USA	INT	CAN	Transmit	Receive
85	85	85	157.275	161.875
85A			157.275	157.275
86	86	86	157.325	161.925
86A			157.325	157.325
87	87	87	157.375	161.975
87A			157.375	157.375
88	88	88	157.425	162.025
88A			157.425	157.425
		21b	Rx only	161.650
		25b	Rx only	161.850
		28b	Rx only	162.000
		83b	Rx only	161.775
WX channel	Frequency (MHz)			
	Transmit	Receive		
1	RX only		162.550	
2	RX only		162.400	
3	RX only		162.475	
4	RX only		162.425	
5	RX only		162.450	
6	RX only		162.500	
7	RX only		162.525	
8	RX only		161.650	
9	RX only		161.775	
10	RX only		163.275	

**NOTE:** Simplex channels 3, 21, 23, 61, 64, 81, 82 and 83 **CANNOT** be lawfully used by the general public in USA waters.

## ◇ GENERAL

- Frequency coverage
  - Marine TX: 156.025 ~ 157.425 MHz
  - RX: 156.050 ~ 163.275 MHz
  - LMR TX/RX: 146.000 ~ 174.000 MHz
- Mode
  - 16K0G3E (Marine)
  - 8K50F3E (Narrow, LMR only)
- Channel spacing:
  - 25 kHz (Marine)
  - 12.5 kHz (Narrow, LMR only)
- Current drain (at 7.2 V DC):
  - TX High (5 W) 1.6 A typical
  - Max. audio 200 mA typical
  - Power save 20 mA typical
  - ±5.0 ppm (−30°C ~ +60°C)
- Frequency stability:
- Usable temperature range
  - Marine: −20°C ~ +60°C, −4°F ~ +140°F
  - LMR: −30°C ~ +60°C, −22°F ~ +140°F
- Dimensions (Projections not included)
  - With BP-227UL: 62 (W) × 97 (H) × 39 (D) mm
  - 2.4 (W) × 3.8 (H) × 1.5 (D) inch
- Weight (approximately)
  - With BP-227UL: 280 g (9.9 oz)

## ◇ TRANSMITTER

- Output power: 5 W (Hi), 3 W (Mid) and 1 W (Low)
- Modulation system: Variable reactance frequency modulation
- Maximum frequency deviation: ±5 kHz (Marine)
- ±2.5 kHz (Narrow, LMR only)
- Audio harmonics distortion: Less than 10% (at 60% mod.)
- Spurious emissions: Less than −70 dBc typical

## ◇ RECEIVER

- Receive system: Double-conversion superheterodyne
- Sensitivity (12 dB SINAD): 0.25 μV typical
- Squelch sensitivity: Less than 0.35 μV (at threshold)
- Intermodulation rejection ratio: 70 dB typical
- Spurious response rejection ratio: 70 dB typical
- Adjacent channel selectivity: 70 dB typical (Marine)
- 60 dB typical (Narrow, LMR only)
- Hum and noise ratio: More than 40 dB (Marine)
- More than 34 dB (Narrow, LMR only)
- Audio output power: 0.35 W typical at 10% distortion into an 8 Ω load

**All stated specifications are subject to change without notice or obligation.**

# 14 OPTIONS

## ◇ BATTERY PACK

- **BP-227UL** Li-ion BATTERY PACK  
Voltage: 7.4 V  
Capacity: 1850 mAh (minimum)/1950 mAh (typical)  
BP-227UL must be charged with the supplied BC-152N or the optional BC-190/BC-197.

## ◇ CHARGER

- **BC-190** DESKTOP CHARGER + **BC-123S** AC ADAPTER  
For rapid charging of battery packs. A power adapter is supplied with the charger.  
Charging time: Approximately 2 ~ 2.5 hours
- **BC-197** MULTI-CHARGER+ **AD-128** CHARGER ADAPTER + **BC-157S** AC ADAPTER  
For rapid charging of up to 6 battery packs simultaneously. A power adapter and 6 charger adapters are supplied.  
Charging time: Approximately 2 ~ 2.5 hours.
- **BC-152N** DESKTOP CHARGER + **BC-147S** AC ADAPTER  
Used for regular charging of battery pack. The same as supplied with the transceiver.  
Charging time: Approximately 10 hours

## ◇ DC CABLES

- **CP-23L** CIGARETTE LIGHTER CABLE  
Enables charging of the battery pack through a 12 V cigarette lighter socket. For use with the BC-190/BC-152N.
- **OPC-515L/OPC-656** DC POWER CABLES  
Enables charging of the battery pack using a 13.8 V power source instead of the power adapter.  
OPC-515L: For BC-190/BC-152N  
OPC-656: For BC-197

## ◇ OTHER OPTIONS

- **MB-86** SWIVEL BELT CLIP  
Swivel type belt clip. The same as supplied with the transceiver.
- **MB-98** BELT CLIP
- **MB-96N/MB-96F/MB-96FL** LEATHER BELT HANGER
- **HM-168IS** SPEAKER-MICROPHONE  
Full-sized waterproof (IPX7 waterproof protection) speaker-microphones including alligator type clip to attach to your shirt or collar.
- **FA-S59V** FLEXIBLE ANTENNA

Available or applicable options may differ according to countries. Ask your authorized dealer for details.



# QUICK REFERENCE 15

Important operating instructions are summed up in this Quick Guide for your simple reference.

By cutting along the line and folding on the dotted line, it will become a card sized operating guide which can easily be carried in a card case or wallet.

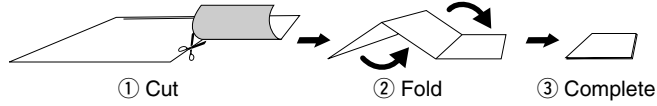

## ICOM OPERATION GUIDE IC-M88

### ■ IN CASE OF EMERGENCY

- USING CHANNEL 16
- DISTRESS CALL PROCEDURE**
  1. MAYDAY MAYDAY MAYDAY.
  2. THIS IS (name of vessel)
  3. Your call sign or other indication of the vessel.
  4. LOCATED AT (your position)
  5. The nature of the distress and assistance required.
  6. Any other information which might facilitate the rescue.

SCUT HERE

### • CHANNEL SELECTION (pp. 8, 9)



•Channel 16

Push



•Channel 9/Call channel

Hold down



for 1 second

•Weather channel



Push



•USA/International/Canadian/LAND channels

Hold down



for 1 second

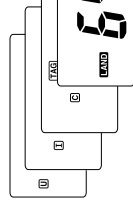

•Call channel programming (p. 12)

- ① Hold down [CH/WX-U/I/C] for 1 second once or several times, to select the desired channel group.
- ② Hold down [16-9] for 1 second to select the Call channel.
- ③ Hold down [16-9] for 3 seconds (until long beep changes to 2 short beeps)
- ④ Push [▲] or [▼] to select the desired channel.
- ⑤ Push [16-9] to program the displayed channel as the Call channel.

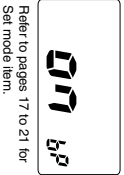

■ **SET MODE** (pp. 17–21)

- 1 While holding down [SQL], turn ON the power.
- 2 Push [SQL] to select an item.  

- 3 Push [▲] or [▼] to select the desired option.
- 4 Push [16-9] to return to regular operating mode.

■ **DUAL/TRI-WATCH** (p. 15)

- 1 Push [▲] or [▼] to select the desired channel.
- 2 Hold down [SCAN+DUAL] for 1 second to start Dualwatch or Tri-watch depending on the Set mode setting (p. 19).

■ **LOCK FUNCTION** (p. 12)

- Hold down
- 
- 1 Push [▲] or [▼] to select the desired channel.
  - 2 Hold down both [▲] and [▼] for 1 second to set the displayed channel as a Tag channel.

■ **TAG CHANNELS** (p. 14)

- 1 Push [▲] or [▼] to select the desired channel.
- 2 Hold down both [▲] and [▼] for 1 second to set the displayed channel as a Tag channel.

■ **SCAN** (p. 14)

- Push [SCAN+DUAL] to start or stop scanning.

■ **WEATHER ALERT** (p. 9)

(Available for USA version only)

- 1 Turn ON the Weather Alert item in the Set mode (p. 18).
- 2 Select WX channel, or start scanning.

## ■ UL information



Versions of the IC-M88 which display the “UL LISTED” marking on the serial number seal.

Non-incendive: Class I, Division 2,  
Groups A, B, C, D T6  
(≤85°C)

when used with Icom  
BP-227UL battery pack.

Approved accessories: Speaker-microphone,  
HM-168IS

Ambient temperature: -20°C to +40°C

Standards of safety: ANSI/ISA 12.12.01-2013

**WARNING! NEVER** charge the BP-227UL (with/without the transceiver) in an explosive atmosphere.

When the transceiver is used in a hazardous area, the BP-227UL **MUST** be attached, either the jack cover or HM-168IS **MUST** be attached to the speaker-microphone connector.

Repair of Icom transceivers should only be carried out by authorized Icom distributors. In particular, repair of UL approval transceivers can **ONLY** be done by Icom. **NEVER** attempt to repair an UL approved transceivers. Only Icom has the repair expertise and procedures to maintain the UL approval. Contact your Icom distributor or authorised dealer for details.

- **DO NOT OPEN WHEN AN EXPLOSIVE ATMOSPHERE MAY BE PRESENT.**
- **DO NOT CHARGE THE BATTERY IN HAZARDOUS LOCATION.**

The equipment can be used without the microphone but with the jack cover.

---

## INDEX

	A				
Accessories .....		2			
Attachment .....		2			
	B				
Backlight .....		11			
Basic operation .....		8			
Battery charger .....		24			
Battery charging .....		22			
	C				
Call channel .....		12			
Channel .....		8			
Channel, Selecting .....		8			
Channel, Tag .....		14			
Channel list .....		30			
	D				
Dualwatch .....		15			
	F				
Function display .....		6			
	L				
Land Channel .....		16			
Lock function .....		11			
	O				
Options .....		32			
	P				
Panel description .....		4			
	Q				
Quick reference .....		33			
	R				
Receiving .....		10			
	S				
Scan .....		13			
Normal scan .....		13			
Priority scan .....		13			
Scan resume timer .....		18			
Set mode					
Items .....		17			
Auto power save .....		20			
Auto scan .....		19			
Automatic backlighting .....		19			
Battery voltage indicator .....		21			
Beep tone .....		18			
LCD contrast .....		20			
Monitor key action .....		19			
Priority scan .....		18			
Scan resume timer .....		18			
Self check .....		20			
Weather alert .....		18			
Speaker microphone .....		28			
Specifications .....		31			
Squelch .....		11			
	T				
Transmitting .....		10			
Tri-watch .....		15			
Troubleshooting .....		29			



---

MEMO

---

---

---

---

---

---

---

---

---

---

---

---

---

---

---

---

---

---

---

---

---

---

---

---

---

---

---

---



**Count on us!**

A-7330D-1EX  
Printed in Japan  
© 2016 Icom Inc.

Printed on recycled paper with soy ink.

**Icom Inc.**  
1-1-32 Kamiminami, Hirano-ku, Osaka 547-0003, Japan