



## INSTRUCTION MANUAL

# VHF MARINE TRANSCEIVER **IC-M72**

This device complies with Part 15 of the FCC Rules. Operation is subject to the condition that this device does not cause harmful interference.

**Icom Inc.**



---

# SAFETY TRAINING INFORMATION

---



**WARNING**

Your Icom radio generates RF electromagnetic energy during transmit mode.

This radio has been evaluated for compliance at the distance of 2.5 cm with the FCC RF exposure limits for “Occupational Use Only”. In addition, your Icom radio complies with the following Standards and Guidelines with regard to RF energy and electromagnetic energy levels and evaluation of such levels for exposure to humans:

- FCC OET Bulletin 65 Edition 97-01 Supplement C, Evaluating Compliance with FCC Guidelines for Human Exposure to Radio Frequency Electromagnetic Fields.
- American National Standards Institute (C95.1-1992), IEEE Standard for Safety Levels with Respect to Human Exposure to Radio Frequency Electromagnetic Fields, 3 kHz to 300 GHz.
- American National Standards Institute (C95.3-1992), IEEE Recommended Practice for the Measurement of Potentially Hazardous Electromagnetic Fields— RF and Microwave.
- The following accessories are authorized for use with this product. Use of accessories other than those specified may result in RF exposure levels exceeding the FCC requirements for wireless RF exposure.; Belt Clip (MB-86, MB-103), Rechargeable Li-Ion Battery Pack (BP-245N), Speaker-microphone (HM-125), Headset with headset adapter (HS-94, HS-95, HS-97 with OPC-1392).



**CAUTION**

**To ensure that your expose to RF electromagnetic energy is within the FCC allowable limits for occupational use, always adhere to the following guidelines:**

- **DO NOT** operate the radio without a proper antenna attached, as this may damaged the radio and may exceed FCC RF exposure limits. A proper antenna is the antenna supplied with this radio by the manufacturer or an antenna specifically authorized by the manufacturer for use with this radio.
- **DO NOT** transmit for more than 50% of total radio use time (“50% duty cycle”). Transmitting more than 50% of the time can cause FCC RF exposure compliance requirements to be exceeded. The radio is transmitting when the “TX indicator” lights. When the radio is turned ON, pressing the “PTT” switch makes the radio transmit.
- **ALWAYS keep** the antenna at least 2.5 cm (1 inch) away from the body when transmitting and only use one of the belt clips listed on page 33 when attaching the radio to your belt, etc., to ensure FCC RF exposure compliance requirements are not exceeded. To provide the recipients of your transmission the best sound quality, hold the radio in an almost vertical position at least 5 cm (2 inches) from your mouth. The microphone is located next to the speaker, so you should “talk into the speaker”.

The information listed above provides the user with the information needed to make him or her aware of RF exposure, and what to do to assure that this radio operates within FCC RF exposure limits.

## **Electromagnetic Interference/Compatibility**

During transmissions, your Icom radio generates RF energy that can possibly cause interference with other devices or systems. To avoid such interference, turn off the radio in areas where signs are posted to do so. **DO NOT** operate the transmitter in areas that are sensitive to electromagnetic radiation such as hospitals, aircraft, and blasting sites.

---

## IN CASE OF EMERGENCY

---

If your vessel requires assistance, contact other vessels and the Coast Guard by sending a distress call on Channel 16.

○ **USING CHANNEL 16**

**DISTRESS CALL PROCEDURE**

1. "MAYDAY MAYDAY MAYDAY."
2. "THIS IS ....." (name of vessel)
3. Say your call sign or other indication of the vessel.
4. "LOCATED AT ....." (your position)
5. State the nature of the distress and assistance required.
6. Give any other information which might facilitate the rescue.

---

## RECOMMENDATION

---

**CLEAN THE TRANSCEIVER THOROUGHLY WITH FRESH WATER** after exposure to saltwater, and dry it before operation. Otherwise, the transceiver's keys, switches and controllers may become inoperable due to salt crystallization.

**NOTE: DO NOT** wash the transceiver in water if there is any reason to suspect the waterproofing may not be effective. For example, in cases where the transceiver/battery pack is cracked or broken, or has been dropped, or when the battery pack is detached from the transceiver.



---

## FOREWORD

---

Thank you for purchasing this Icom radio. The IC-M72 VHF MARINE TRANSCEIVER is designed and built with Icom's state of the art technology and craftsmanship. With proper care this product should provide you with years of trouble-free operation.

---

## IMPORTANT

---

**READ ALL INSTRUCTIONS** carefully and completely before using the transceiver.

**SAVE THIS INSTRUCTION MANUAL**—This instruction manual contains important operating instructions for the IC-M72.

---

## EXPLICIT DEFINITIONS

---

WORD	DEFINITION
<b>⚠ DANGER</b>	Personal death, serious injury or an explosion may occur.
<b>⚠ WARNING</b>	Personal injury, fire hazard or electric shock may occur.
<b>CAUTION</b>	Equipment damage may occur.
<b>NOTE</b>	If disregarded, inconvenience only. No risk of personal injury, fire or electric shock.

---

## FEATURES

---

### **Submersible construction**

Built tough to withstand the punishing marine environment, the IC-M72's submersible construction meets IPX8 of the corresponding International Standard IEC 60529 (2001) while using BP-245N.

In addition, the new speaker grill structure with a water self-draining function is helpful for draining water or seawater easily.

### **Dualwatch and tri-watch functions**

Convenient functions that allow you to monitor the distress channel (Ch 16) while receiving one other channel of your choice (dualwatch), or while receiving one other channel of your choice and the call channel (Ch 09) (tri-watch). See p. 16 for details.

### **Large, easy-to-read LCD**

With the generous dimensions of 22.5(H) × 31.5(W) mm; 7/8(H) × 1 1/4(W) inch, the IC-M72's function display is easy to read and shows operating conditions at a glance. Backlighting and contrast can be adjusted to suit your preferences.

### **Simple operation**

The volume knob is on top of the radio, while the channel buttons are on the front panel. This allows for convenient, one-handed operation.

---

## PRECAUTION

---

**⚠ WARNING! NEVER** connect the transceiver to an AC outlet. This may pose a fire hazard or result in an electric shock.

**⚠ WARNING! NEVER** hold the transceiver so that the antenna is closer than 2.5 cm (1 inch) from exposed parts of the body, especially the face or eyes, while transmitting. The transceiver will perform best if the microphone is 5 to 10 cm (2 to 4 inches) away from the lips and the transceiver is vertical.

**NEVER** connect the transceiver to a power source other than the BP-245N. Such a connection will ruin the transceiver.

**AVOID** using or placing the transceiver in direct sunlight or in areas with temperatures below  $-20^{\circ}\text{C}$  ( $-4^{\circ}\text{F}$ ) or above  $+60^{\circ}\text{C}$  ( $+140^{\circ}\text{F}$ ).

**KEEP** the transceiver out of the reach of children.

**KEEP** the transceiver at least 0.9 meters (3.0 ft) away from your vessel's magnetic navigation compass.

**MAKE SURE** the flexible antenna and battery pack are securely attached to the transceiver, and that the antenna and battery pack are dry before attachment. Exposing the inside of the transceiver to water will result in serious damage to the transceiver.

**BE CAREFUL!** The IC-M72 employs submersible construction (1.5 m; 4.9 ft depth for 30 min.). However, once the transceiver has been dropped, waterproofing cannot be guaranteed due to the fact that the transceiver may be cracked, or the waterproof seal damaged, etc.

*For the U.S.A. only*

**CAUTION:** Changes or modifications to this device, not expressly approved by Icom Inc., could void your authority to operate this device under FCC regulations.

Icom, Icom Inc. and the Icom logo are registered trademarks of Icom Incorporated (Japan) in the United States, the United Kingdom, Germany, France, Spain, Russia and/or other countries.

---

# TABLE OF CONTENTS

---

SAFETY TRAINING INFORMATION.....	i
IN CASE OF EMERGENCY.....	ii
RECOMMENDATION.....	ii
FOREWORD.....	iii
IMPORTANT.....	iii
EXPLICIT DEFINITIONS.....	iii
FEATURES.....	iii
PRECAUTION.....	iv
TABLE OF CONTENTS.....	v
<b>1 OPERATING RULES.....</b>	<b>1</b>
<b>2 SUPPLIED ACCESSORIES AND ATTACHMENTS.....</b>	<b>2-3</b>
■ Supplied accessories.....	2
■ Attachments.....	2
<b>3 PANEL DESCRIPTION.....</b>	<b>4-6</b>
■ Front, top and side panels.....	4
■ Function display.....	5
<b>4 BASIC OPERATION.....</b>	<b>7-13</b>
■ Channel selection.....	7
■ Receiving and transmitting.....	9
■ Call channel programming.....	10
■ Lock function.....	10
■ Monitor function.....	10
■ Adjusting the squelch level.....	11
■ Backlighting function.....	11
■ Voice scrambler operation.....	11
■ VOX function.....	12
■ AquaQuake water draining function.....	12
■ Channel naming.....	12
<b>5 SCAN OPERATION.....</b>	<b>14-15</b>
■ Scan types.....	14
■ Setting TAG channels.....	15
■ Starting a scan.....	15
<b>6 DUALWATCH/TRI-WATCH.....</b>	<b>16</b>
■ Description.....	16
■ Operation.....	16
<b>7 SET MODE.....</b>	<b>17-22</b>
■ SET mode programming.....	17
■ SET mode items.....	18
<b>8 BATTERY CHARGING.....</b>	<b>23-27</b>
■ Battery cautions.....	23
■ Supplied battery charger.....	25
■ Optional battery chargers.....	26
<b>9 OPTIONAL SWIVEL BELT CLIP.....</b>	<b>28</b>
■ Attachment.....	28
■ Detachment.....	28
<b>10 OPTIONAL SPEAKER-MICROPHONE.....</b>	<b>29</b>
■ HM-125 descriptions.....	29
■ Attachment.....	29
<b>11 TROUBLESHOOTING.....</b>	<b>30</b>
<b>12 VHF MARINE CHANNEL LIST.....</b>	<b>31</b>
<b>13 SPECIFICATIONS.....</b>	<b>32</b>
<b>14 OPTIONS.....</b>	<b>33</b>

## ◇ **Priorities**

- Read all rules and regulations pertaining to priorities and keep an up-to-date copy handy. Safety and distress calls take priority over all others.
- You must monitor Channel 16 when you are not operating on another channel.
- False or fraudulent distress calls are prohibited under law.

## ◇ **Privacy**

- Information overheard but not intended for you cannot lawfully be used in any way.
- Indecent or profane language is prohibited.

## ◇ **Radio licenses**

### **(1) SHIP STATION LICENSE**

When your craft is equipped with a VHF FM transceiver, you must have a current radio station license before using the transceiver. It is unlawful to operate a ship station which is not licensed.

Inquire through your dealer or the appropriate government agency for a Ship-Radiotelephone license. This license includes the call sign which is your craft's identification for radio purposes.

### **(2) OPERATOR'S LICENSE**

A restricted Radiotelephone Operator Permit is the license most often held by small vessel radio operators when a radio is not required for safety purposes.

The Restricted Radiotelephone Operator Permit must be posted near the transceiver or be kept with the operator. Only a licensed radio operator may operate a transceiver.

However, non-licensed individuals may talk over a transceiver if a licensed operator starts, supervises, ends the call and makes the necessary log entries.

A current copy of the applicable government rules and regulations is only required to be on hand for vessels in which a radio telephone is compulsory. However, even if you are not required to have these on hand it is your responsibility to be thoroughly acquainted with all pertinent rules and regulations.

**NOTE:** Even though the IC-M72 is capable of operation on VHF marine channels 3, 21, 23, 61, 64, 81, 82 and 83, according to FCC regulations these simplex channels cannot be lawfully used by the general public in USA waters.

## ■ Supplied accessories

The following accessories are supplied:

	Qty.
① Handstrap .....	1
② Battery charger .....	1
③ Screws for the battery charger (M3.5×30).....	2
④ Belt clip (with screws) .....	1
⑤ AC adapter .....	1
⑥ Li-Ion battery pack .....	1
⑦ Flexible antenna .....	1

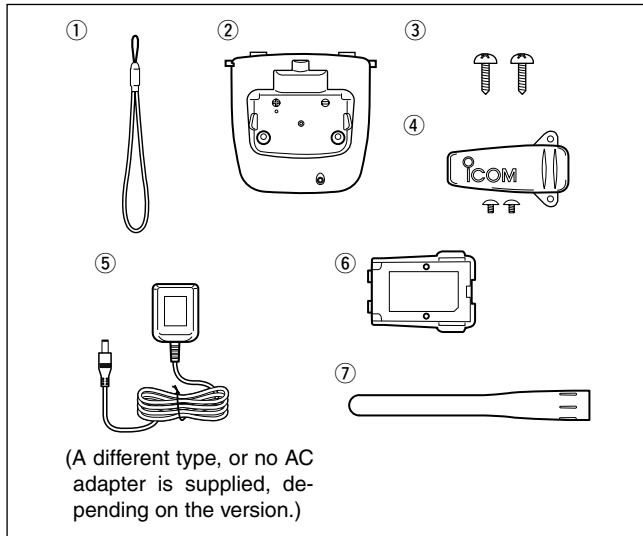

## ■ Attachments

### ◇ Flexible antenna

Connect the supplied flexible antenna to the antenna connector.

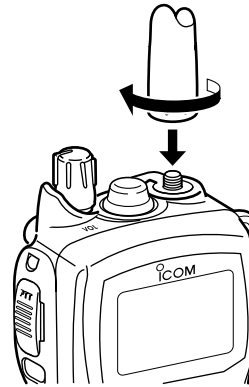

**CAUTION:** Transmitting without an antenna may damage the transceiver.

**NEVER HOLD** by the antenna when carrying the transceiver.

### ◇ Handstrap

Pass the handstrap through the loop on the top corner of the transceiver as illustrated at left. Facilitates carrying.

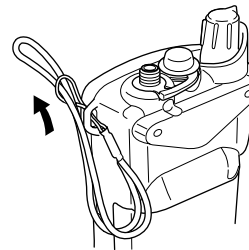



### ◇ Battery pack

- ① Attach the battery pack into the transceiver as below.

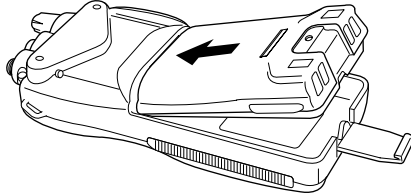

- ② Lock the battery pack with the latch.

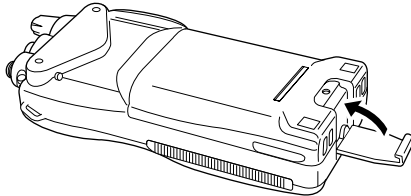

**CAUTION:**  
**NEVER** attach or detach the battery pack when wet.

**Be careful** when releasing the latch. Because the latch is tightly locked, don't use a finger nail to open it— you may injure yourself. Instead, use something relatively flat, like the edge of a coin or the tip of a screwdriver, to carefully release the latch.

### ◇ Belt clip

- Attach the belt clip to the transceiver as illustrated below.

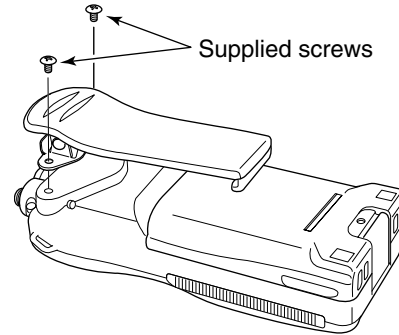

## ■ Front, top and side panels

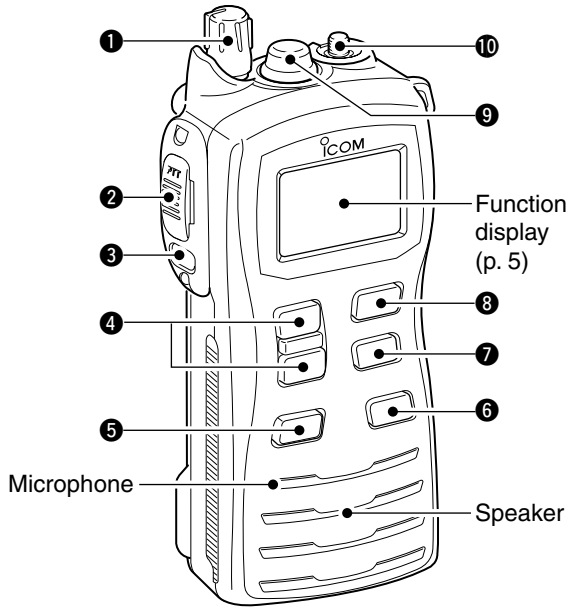

### ① VOLUME CONTROL [VOL]

Turns power ON and adjusts the audio level.

### ② PTT SWITCH [PTT]

Push and hold to transmit; release to receive.

### ③ MONITOR KEY [MON]

- Manually opens the squelch for monitoring the channel while pushed and held. (p. 10)
- Push this switch, then adjust the squelch level with [▲]/[▼]. (p. 11)
- While pushing and holding this switch, turn power ON to enter the SET mode. (p. 17)

### ④ CHANNEL UP/DOWN KEYS [▲]/[▼]

- Selects an operating channel. (pgs. 7–9)
- Selects the SET mode condition of the item. (p. 17)
- Selects the SET mode item when pushed with [MON]. (p. 17)
- Checks TAG channels or changes scanning direction during scan. (p. 15)

### ⑤ CHANNEL 16 KEY [16•9]

- Selects Channel 16 when pushed. (p. 7)
- Selects call channel when pushed for 1 sec. (p. 7)
- Enters call channel write mode when the call channel is selected and this key is pushed and held for 3 sec. (p. 10)

**6 TRANSMIT POWER/LOCK KEY [H/L•LOCK]**

- Selects high, middle or low power when pushed. (p. 9)
- Toggles the lock function ON/OFF when pushed and held for 1 sec. (p. 10)

**7 SCAN KEY [SCAN•DUAL]**

- Starts and stops normal or priority scan when pushed. (pgs. 14, 15)
- Enters watch mode when pushed and held for 1 sec. (p. 16)

**8 CHANNEL/WEATHER CHANNEL KEY [CH/WX•U/I/C]**

- Selects and toggles the regular channels and weather channel when pushed. (p. 8)
- Selects the U.S.A, International, or Canadian\* channel group when pushed and held for 1 sec. (p. 8)
  - The function display shows which channel group is active. \*Available with the USA versions only.
- Push to return to the condition before selecting the channel when the priority channel or the call channel is selected.

**9 SPEAKER-MICROPHONE CONNECTOR [SP MIC]**

Connects the optional external speaker-microphone or headset.

**NOTE:** Attach the [SP MIC] cap when the optional speaker-microphone or headset is not used.

**10 ANTENNA CONNECTOR**

Connects the supplied antenna.

**Function display**

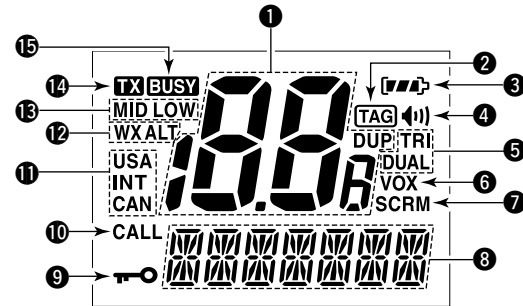

**1 CHANNEL NUMBER READOUT**

- Indicates the selected operating channel number.
- In SET mode, indicates the selected condition.
- “DUP” appears when a duplex channel is selected.

**2 TAG CHANNEL INDICATOR (p. 15)**

Appears when TAG channel is selected.

**3 BATTERY INDICATOR**

Indicates remaining battery power.

Indication				
Battery level	Full	Middle	Charging required	No battery

blinks when the battery is overcharged (or over voltage).

---

### 3 PANEL DESCRIPTION

#### 4 MONITOR INDICATOR (p. 10)

Appears when the monitor function is activated.

#### 5 DUALWATCH/TRI-WATCH INDICATORS (p. 16)

“DUAL” blinks during dualwatch; “TRI” blinks during tri-watch.

#### 6 VOX INDICATOR (p. 12)

Appears when the VOX function is used.

#### 7 SCRAMBLER INDICATOR (pgs. 11, 22)

Appears when the voice scrambler is activated.

\*The voice scrambler function is available with some versions only.

#### 8 CHANNEL NAMING

- Indicates or scrolls operating channel name or comment. (p. 13)
- In SET mode, indicates or scrolls the selected item. (pgs. 17–22)

#### 9 LOCK INDICATOR (p. 10)

Appears when the lock function is activated.

#### 10 CALL CHANNEL INDICATOR (p. 7)

Appears when the call channel is selected.

#### 11 CHANNEL GROUP INDICATOR (p. 8)

“USA” appears when U.S.A.; “INT” appears when International; “CAN\*” appears when Canadian channel group is selected.

#### 12 WEATHER CHANNEL/WEATHER ALERT INDICATORS (p. 8)

- “WX” appears when the weather channel group is selected.
- “WX ALT” appears when the weather alert function is activated.

#### 13 TRANSMIT POWER INDICATORS (p. 9)

- “LOW” appears when low power is selected.
- “MID” appears when middle power is selected.
- No indication appears when high power is selected.

#### 14 TRANSMIT INDICATOR (p. 9)

Appears during transmit.

#### 15 BUSY INDICATOR (pgs. 9, 10)

Appears when a signal is received or squelch is open.

\*Available with the USA versions only.

## ■ Channel selection

**IMPORTANT!:** Prior to using the transceiver for the first time, fully charge the battery pack. This will help maximize the capability and life of the battery. To avoid damage to the transceiver, turn the radio OFF while charging.

### ◇ Channel 16

Channel 16 (Distress channel) is used for establishing initial contact with another station and for emergency communications. Channel 16 is automatically monitored during both dualwatch and tri-watch. While standing by, you must monitor Channel 16.

- ① Push [16•9] to select Channel 16.
- ② Push [CH/WX•U/I/C] to return to the condition before selecting Channel 16, or push [▲]/[▼] to select the operating channel.

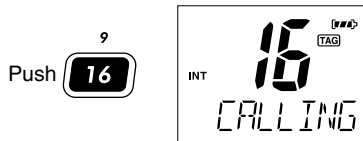

### ◇ Channel 9 (Call channel)

Channel 9 is the leisure-use call channel. Each regular channel group has separate call channels. In addition, the call channel is monitored during tri-watch. The call channels can be re-programmed (p. 10) and may be used to store your most often used channels in each channel group for quick recall.

- ① Push and hold [16•9] for 1 sec. to select the call channel.
  - “CALL” and the call channel number appear.
  - Call channel can be re-programmed. See the “Call channel programming” on p. 10 for details.
- ② Push [CH/WX•U/I/C] to return to the condition before selecting Channel 9 (call channel), or push [▲]/[▼] to select the operating channel.

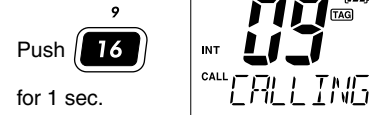

## 4 BASIC OPERATION

### ◇ U.S.A., International and Canadian channels

The IC-M72 has 57 U.S.A., 57 International and 61 Canadian\* channels. You must select the proper channels for the operating area.

\*Available with the USA versions only.

- ① Push **[CH/WX•U/I/C]** to select the regular channel.
  - If the weather channel appears, push **[CH/WX•U/I/C]** again.
- ② Push **[▲]/[▼]** to select a channel.
  - “DUP” appears for duplex channels.
- ③ To change the channel group, push and hold **[CH/WX•U/I/C]** for 1 sec.
  - Repeat until you reach the desired channel group.

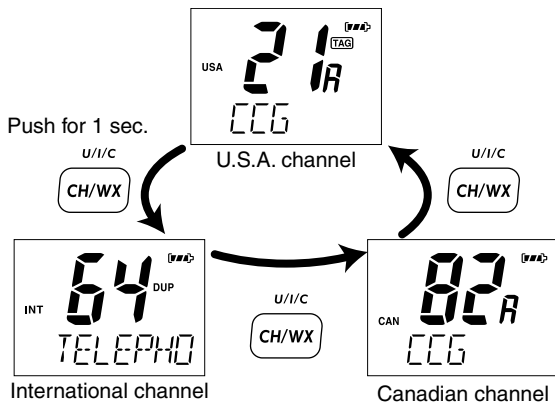

### ◇ Weather channels

The IC-M72 has 10 weather channels. They are used for monitoring NOAA (National Oceanographic and Atmospheric Administration) broadcasts (reception of weather channels possible in U.S.A. only).

- ① Push **[CH/WX•U/I/C]** to select the weather channel group.
- ② Push **[▲]/[▼]** to select a weather channel.
- ③ Push **[CH/WX•U/I/C]** to return to the condition before selecting the weather channel group.

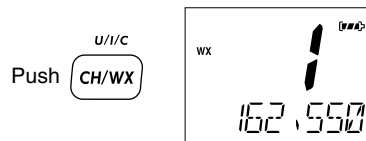

### ✓ CONVENIENT!

The IC-M72 can detect a weather alert tone on the selected weather channel while in another channel (when the power save function is turned ON) or during scanning. See the “SET mode items” on p. 18 for details.

## ■ Receiving and transmitting

**CAUTION:** Transmitting without an antenna may damage the transceiver.

- ① Rotate **[VOL]** clockwise to turn power ON.
  - Opening comment scrolls across the function display. (p. 13)
  - Push **[16•9]** to skip the opening comment indication.
- ② Set the volume and squelch level.
  - ➔ Push **[M]**, and push **[V]** to open the squelch.
  - ➔ Rotate **[VOL]** to set the volume level.
  - ➔ Push **[M]**, and push **[▲]/[▼]** to set the squelch level.
- ③ Push **[▲]/[▼]** to select the desired channel.
  - When receiving a signal, "**BUSY**" indicator appears while audio is emitted from the speaker.
  - Further adjustment of **[VOL]** may be necessary at this point.
- ④ Push **[H/L•LOCK]** to select the output power, if necessary.
  - "LOW" appears when low power is selected; "MID" appears when middle power is selected; no indication when high power is selected.
  - Choose low or mid. power to conserve battery power, choose high power for longer distance communications.
  - Some channels are for low power only.
- ⑤ Push and hold **[PTT]** to transmit, and speak into the microphone.
  - The transmit indicator appears while transmitting.
  - Channel 70 cannot be used for transmission.
- ⑥ Release **[PTT]** to receive.

**IMPORTANT:** To maximize the readability of your transmitted signal, pause a second after pushing **[PTT]**, hold the microphone 5 to 10 cm (2 to 4 inches) from your mouth, and speak into the microphone using a normal voice level.

**NOTE:** The transceiver has a power save function to conserve the battery power. The power save function activates automatically when no signal is received for 5 sec.

To prevent accidental prolonged transmission, etc., the IC-M72 has a time-out timer function. This timer cuts a transmission OFF after 5 min. of continuous transmission.

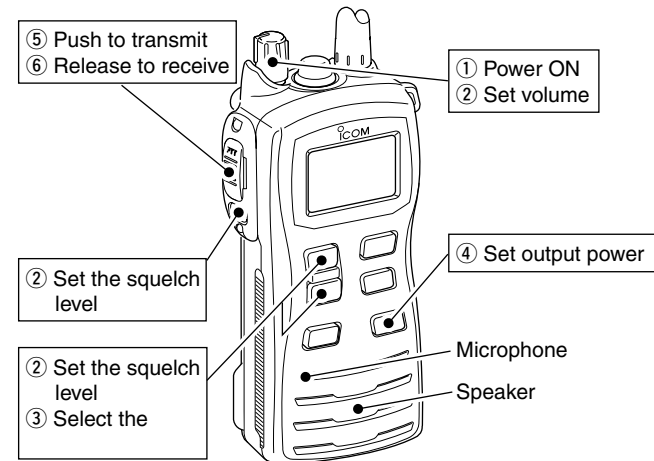

## 4 BASIC OPERATION

### ■ Call channel programming

The call channel key is used to select Channel 9 by default, however, you can program your most often-used channel in each channel group for quick recall.

- ① Push and hold **[CH/WX•U/I/C]** for 1 sec. several times to select the desired channel group (USA, INT, CAN) to be programmed.
- ② Push and hold **[16•9]** for 1 sec. to select the call channel.
  - “CALL” and call channel number appear.
- ③ Push and hold **[16•9]** again for 3 sec. (until a long beep changes to 2 short beeps) to enter call channel programming condition.
  - Call channel number to be programmed blinks.
- ④ Push **[▲]/[▼]** to select the desired channel.
- ⑤ Push **[16•9]** to program the displayed channel as the call channel.
  - The call channel number stops blinking.

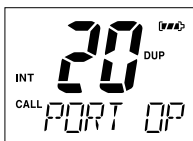
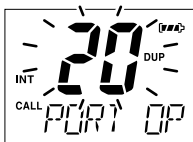
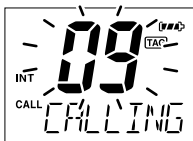
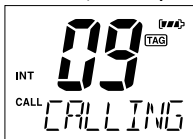

### ■ Lock function

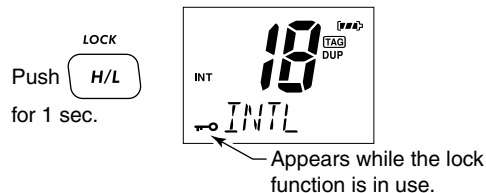

This function electronically locks all keys (except for **[PTT]**, **[**) and **[H/L•LOCK]**) to prevent accidental channel changes and function access.

- ➔ Push **[H/L•LOCK]** for 1 sec. to turn the lock function ON or OFF.



### ■ Monitor function

The monitor function releases the noise squelch mute to check the volume level. See p. 19 for details of the monitor switch action.

- ➔ Push and hold **[**] for 1 sec. to activate the monitor function.
  - “**[**” and “**BUSY**” appear and audio is emitted.

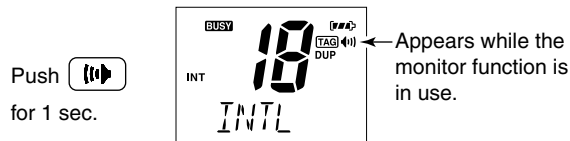



## ■ Adjusting the squelch level

To adjust the IC-M72's squelch level, use the [▲]/[▼] keys as desired below. In order to receive signals properly, as well as for the scan to function effectively, the squelch must be adjusted to the proper level.

- ① Push [(◀▶)], then adjust the squelch level with [▲]/[▼].
  - "SQL" and the squelch level are displayed.
  - There are 11 squelch levels to choose from: OP is completely open; 10 is tight squelch; 1 is loose squelch level.
  - When no key is pushed for 5 sec., the transceiver returns to normal condition.
- ② Push [(◀▶)] again to return to normal operating mode.

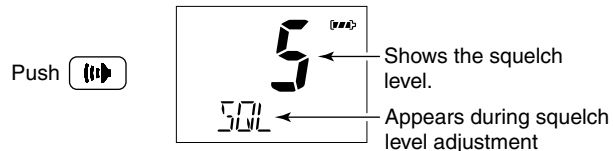

## ■ Backlighting function

This function is convenient for nighttime operation. The backlighting can be turned OFF in the SET mode. (p. 19)

- ➔ Push any key other than [PTT] to turn the backlighting ON.
  - The backlighting is automatically turned OFF after 5 sec. of inactivity.

## ■ Voice scrambler operation (available with some versions only)

### ◇ Activating the scrambler

The voice scrambler provides private communications. In order to receive or send scrambled transmissions, you must activate the scrambler function first.

- ① Select an operating channel other than Channel 16, 70 or weather channels.
- ② While pushing and holding [(◀▶)], push [SCAN•DUAL].
  - "SCRM" appears.
- ③ To turn the scrambler function OFF, repeat step ②.
  - "SCRM" disappears.

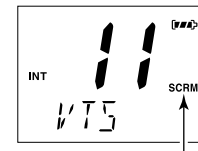

Appears when the voice scrambler function is in use.

### ◇ Programming scramble codes

There are 32 codes (1 to 32) available for programming. Set the code in the SET mode. In order to understand each other, all transceivers in your group must use the same scramble code, as well as the same scrambler unit. See p. 22 for "Scrambler code" setting details.

## 4 BASIC OPERATION

### ■ VOX function

**NOTE:** An optional headset and optional headset adapter are required for the VOX operation.

The VOX function (voice operated transmission) starts transmitting when you speak into the headset's microphone. There is no need to push [PTT]. The IC-M72 automatically returns to receive mode when you stop talking.

- ➔ Push and hold [1], then push [H/L•LOCK] to turn the VOX function ON or OFF while connecting the headset and optional headset adapter to [SP MIC] connector.
  - “VOX” appears on the LCD while the VOX function turns ON.
  - The VOX gain and VOX delay can be set on the SET mode. (p. 22)
  - During scan, dual/tri-watch or on a transmission inhibited channel, the VOX function will not be activated.

### ■ AquaQuake water draining function

The IC-M72 uses a new technology to clear water away from the speaker grill: AquaQuake. AquaQuake helps drain water away from the speaker housing (water that might otherwise muffle the sound coming from the speaker). The IC-M72 emits a vibrating noise when this function is being used.

- ➔ Push and hold both [16•9] and [H/L•LOCK].
  - A low beep tone sounds for 9 sec. to drain water, regardless of [VOL] control setting.
  - The transceiver never accepts a key operation while the AquaQuake function is activated. And this function won't be activated when an optional speaker-microphone or headset is connected.

### ■ Channel naming

The IC-M72 has a capability to assign up to 10-character channel names or comments for each operating channel, including each weather channel. This provides easy recognition of channel usage, or station names, etc.

When shipped from the factory, the IC-M72 is programmed with default names for each VHF marine channel. These defaults can be changed, if desired.

You may replace the factory-set opening comment with a comment of your own. The opening comment appears each time the IC-M72 is powered ON. The comment may be up to 16 characters long.

#### ◇ Available characters

-- (=)	✳ (*)	+ (+)	-- (-)	, (,)	/ (/)	0 (0)	1 (1)	2 (2)	3 (3)
4 (4)	5 (5)	6 (6)	7 (7)	8 (8)	9 (9)	(Space)	A (A)	B (B)	C (C)
D (D)	E (E)	F (F)	G (G)	H (H)	I (I)	J (J)	K (K)	L (L)	M (M)
N (N)	O (O)	P (P)	Q (Q)	R (R)	S (S)	T (T)	U (U)	V (V)	W (W)
X (X)	Y (Y)	Z (Z)	a (a)	b (b)	c (c)	d (d)	e (e)	f (f)	g (g)
h (h)	i (i)	j (j)	k (k)	l (l)	m (m)	n (n)	o (o)	p (p)	q (q)
r (r)	s (s)	t (t)	u (u)	v (v)	w (w)	x (x)	y (y)	z (z)	

◇ Channel name/comment programming

- ① Push [▲]/[▼] to select a channel to program.  
 • Push and hold [CH/WX•U/I/C] for 1 sec. to select a channel group, if necessary.

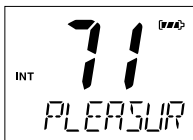

- ② While pushing and holding [(◀▶)], push [CH/WX•U/I/C].  
 • The 1st character of the currently programmed name or comment blinks.

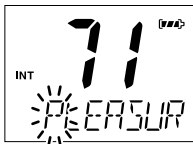

- ③ Push [▲]/[▼] to select a character.



- ④ Push [H/L•LOCK] to move to the right; then push [▲]/[▼] to select a character.  
 • Pushing [16•9], moves to left

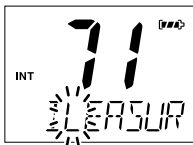

- ⑤ Continue until the desired characters have been selected, then push [CH/WX•U/I/C] to return to normal operation.

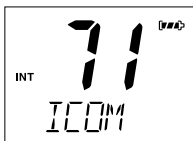

◇ Opening comment programming

- ① While pushing and holding [SCAN•DUAL], turn power ON.  
 • "OC" is displayed and the 1st character of the currently programmed comment blinks.



- ② Push [▲]/[▼] to select a character.

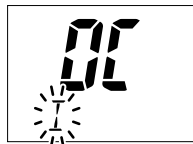

- ③ Push [H/L•LOCK] to move to the right; then push [▲]/[▼] to select a character.  
 • Pushing [16•9], moves to left

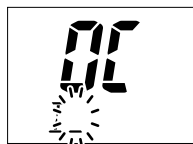

- ④ Continue until the desired characters have been selected, then push [CH/WX•U/I/C] to return to normal operation.

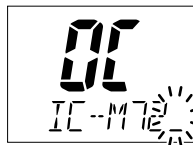

▨ The programmed opening comment is briefly displayed or scrolled when the transceiver is powered ON.  
 ▨ However, the opening comment indication can be skipped by pushing [16•9].

## ■ Scan types

Scanning is an efficient way to quickly locate signals over a wide frequency range. The transceiver has a priority scan setting and normal scan setting.

In addition, the “Weather alert” and “Auto scan” functions are also available for scanning. These functions can be activated simultaneously, depending on the settings on the SET mode. (pgs. 18, 19)

### PRIORITY SCAN

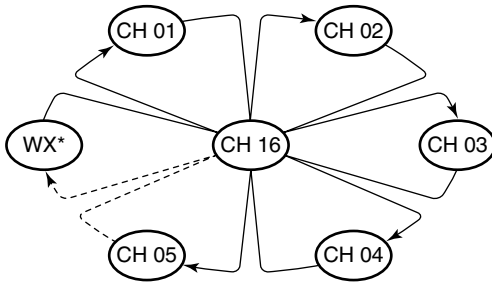

\* Previously selected weather channel when weather alert function is ON

Priority scan searches through all TAG channels in sequence while monitoring Channel 16. When a signal is detected on Channel 16, scan pauses until the signal disappears; when a signal is detected on a channel other than Channel 16, scan becomes dualwatch until the signal disappears.

Set the TAG channels (scanned channel) before scanning. Clear those TAG channels which are not needed or inconveniently stop scanning, such as digital communications.

⚡ Choose priority or normal scan on the SET mode. (p. 18)

### NORMAL SCAN

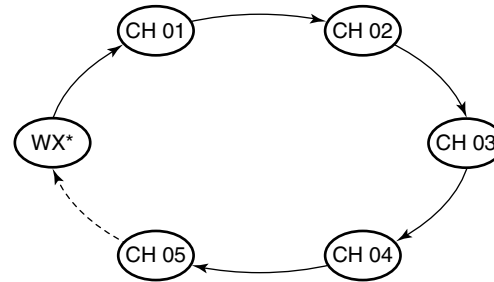

\* Previously selected weather channel when weather alert function is ON.

Normal scan, like priority scan, searches through all TAG channels in sequence. However, unlike priority scan, Channel 16 is not checked unless Channel 16 is set as a TAG channel.

## ■ Setting TAG channels

For more efficient scanning, add desired channels as TAG channels or clear the TAG for unwanted channels. Untagged will be skipped during scanning. TAG channels can be assigned to each channel group (USA, INT, CAN) independently.

- ① Select the desired channel to set as a TAG channel.
- ② Push and hold both [▲] and [▼] for 1 sec. to set the displayed channel as a TAG channel.
  - “TAG” appears in the function display.
- ③ To cancel the TAG channel setting, push and hold both [▲] and [▼] for 1 sec.
  - “TAG” disappears.

**✓ Clearing All Tagged Channels in the Selected Channel Group**  
 While pushing and holding both [▲] and [▼], turn power ON to clear all TAG channels setting in the channel group.

## ■ Starting a scan

Set the weather alert function, priority scan function, scan resume timer and auto scan function in advance, using the SET mode. (pgs. 18, 19)

- ① Make sure the desired channel group (e.g., USA, CAN, INT) is selected. Move between channel groups by repeatedly pushing [CH/WX•U//C] for 1 sec. at a time.
  - When the weather alert function is in use, select the desired weather channel with [CH/WX•U//C] and [▲]/[▼].
- ② Push [SCAN•DUAL] to start priority or normal scan.
  - “SCAN” blinks in the function display.
  - “16” appears on the comment indicator during priority scan.
  - When a signal is received, scan pauses until the signal disappears or resumes after pausing 5 sec. according to scan resume timer setting. (Channel 16 is still monitored during priority scan.)
  - Push [▲]/[▼] to check the scanning TAG channels, change the scanning direction or resume the scan manually.
- ③ To stop the scan, push [SCAN•DUAL].
  - “SCAN” disappears.
  - Pushing [PTT], [16•9] or [CH/WX•U//C] also stops the scan.

5

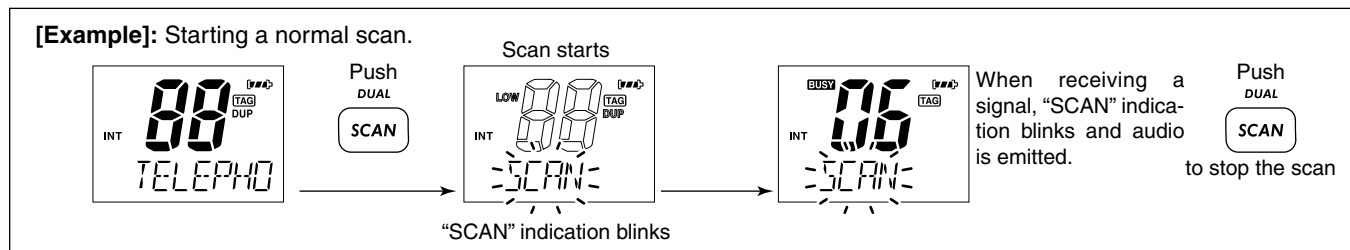

## ■ Description

Dualwatch monitors Channel 16 while you are receiving another channel; tri-watch monitors Channel 16 and the call channel while receiving another channel.

### DUALWATCH/TRI-WATCH SIMULATION

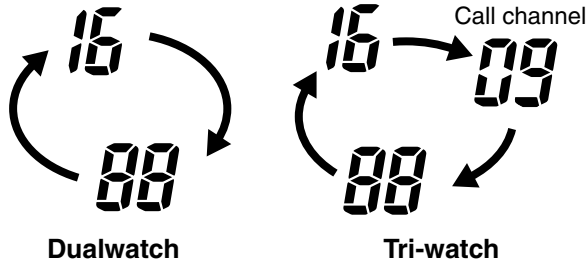

- If a signal is received on Channel 16, dualwatch/tri-watch pauses on Channel 16 until the signal disappears.
- If a signal is received on the call channel during tri-watch, tri-watch becomes dualwatch until the signal disappears.
- To transmit on the selected channel during dualwatch/tri-watch, push and hold [PTT].

## ■ Operation

- ① Select the desired operating channel.
- ② Push [SCAN•DUAL] for 1 sec. to start dualwatch or tri-watch (depending on the SET mode setting; p. 19).
  - “DUAL” blinks during dualwatch; “TRI” blinks during tri-watch.
  - A beep tone sounds when a signal is received on Channel 16.
  - Tri-watch becomes dualwatch when receiving a signal on the call channel.
- ③ To cancel dualwatch/tri-watch, push [SCAN•DUAL] again.

[Example]: Operating tri-watch on INT channel 07.

Push <sup>DUAL</sup>SCAN for 1 sec.

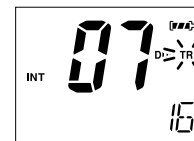

Tri-watch starts.

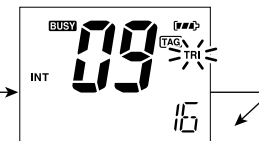

Signal is received on the call channel.

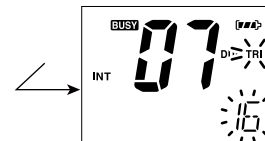

A signal receive on Channel 16 always takes priority.

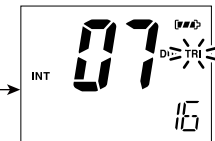

Tri-watch resumes after the signal disappears.

## ■ SET mode programming

SET mode is used to change the condition of 18 transceiver functions: beep tone function, weather alert function, scan type, scan resume timer, auto scan function, dual/tri-watch function, monitor key action, backlighting function, LCD contrast selection, auto power save function, self check function, battery voltage indication, squelch sensitivity, channel name scroll type, scroll speed, scrambler code, VOX gain and VOX delay.

### ◇ SET mode operation

- ① Turn power OFF.
- ② While pushing and holding [F], turn power ON to enter the SET mode.
  - "BEEP" (Beep tone function setting) appears.
- ③ Push [F], or push [F] and [▲]/[▼] to select the desired item.
- ④ Push [▲]/[▼] to select the desired condition of the item.
- ⑤ To exit the SET mode, push [16•9].

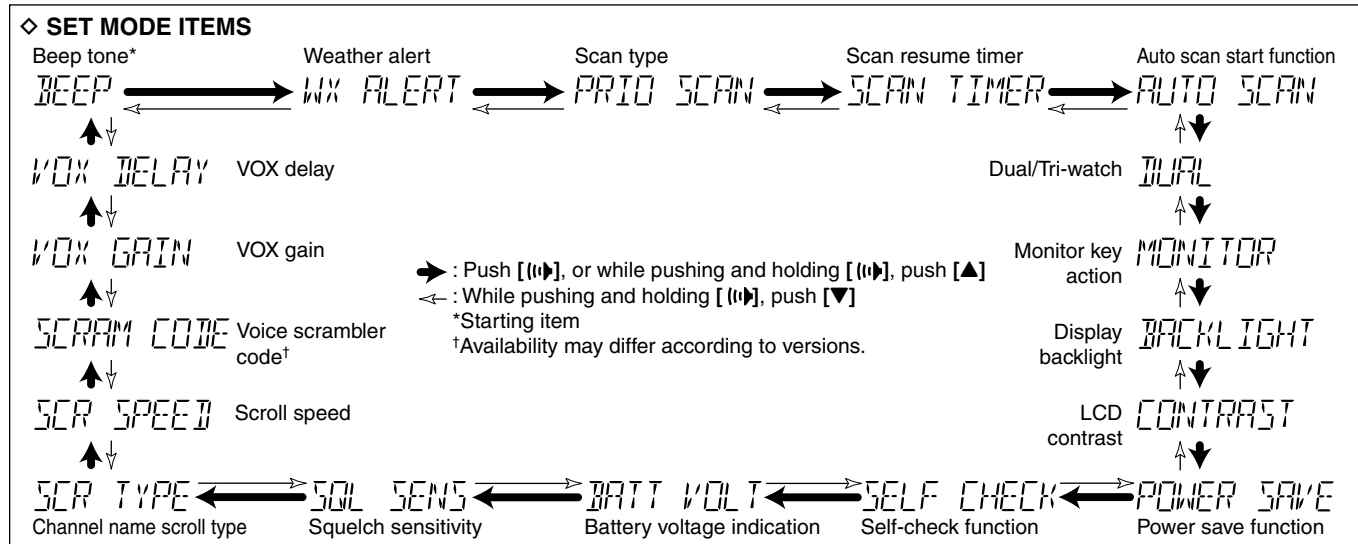

## ■ SET mode items

### ◇ Beep tone function “BEEP”

Selects the key touch beep sound ON or US, or turns sound OFF.

- ON : A fixed beep sounds (default)
- US : The preset beeps (e.g. do, re, mi) sound
- OFF : Silent operation

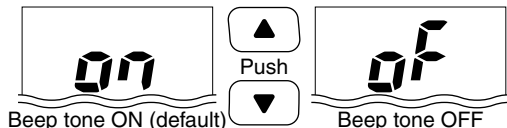

### ◇ Weather alert function “WX ALERT”

A NOAA broadcast station transmits a weather alert tone before any important weather announcements. When the weather alert function is turned ON, any detected weather alert will make the IC-M72 activate a blinking “WXALT” alert indicator on the function display and repeatedly sound a beep tone. The blinking and beeping stops when the radio is picked up and operated. The previously selected weather channel is checked any time during standby, or while scanning, when the power save function is activated.

- “ALT” appears when the function is set ON.

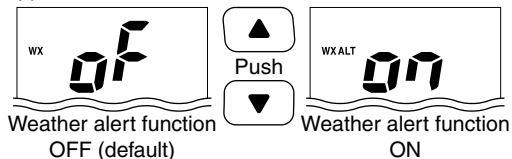

### ◇ Priority scan function “PRIO SCAN”

The transceiver has 2 scan types— normal (OFF) and priority (ON) scans. Normal scan searches all TAG channels in the selected channel group. Priority scan searches all TAG channels in sequence while monitoring Channel 16.

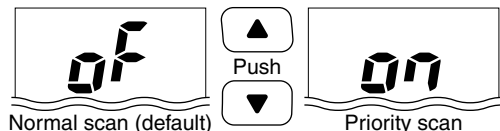

### ◇ Scan resume timer “SCAN TIMER”

The scan resume timer can be set as a pause (OFF) or timer scan (ON). When OFF is selected, the scan pauses until a received signal disappears. When ON is selected, the scan pauses for 5 sec. after receiving a signal and then resumes even if the signal has been received.

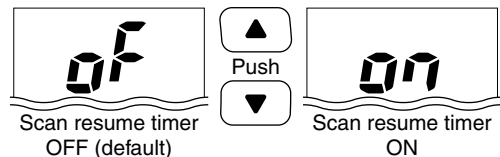



◇ **Auto scan function**

“AUTO SCAN”

The auto scan function starts the desired scan automatically when no signal is received, and no operation is performed for 30 sec.

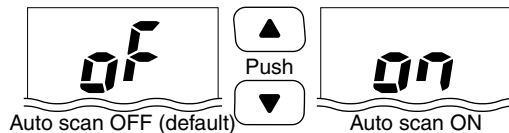

◇ **Dual/Tri-watch function**

“DUAL”

This item selects dual or tri-watch as desired. See p. 16 for details.

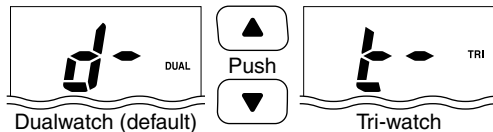

◇ **Monitor key action**

“MONITOR”

The monitor key action cuts off the squelch function temporarily. This key action contains PUSH (Pu) or HOLD (Ho) settings as shown below.

- Pu (PUSH): After pushing [MON] for 1 sec., the squelch opens and emits audio. The squelch is held open while continuously pushing and holding [MON]. (default)
- Ho (HOLD): After pushing [MON] for 1 sec., the squelch opens and emits audio even [MON] is released. To close the squelch, push any key.

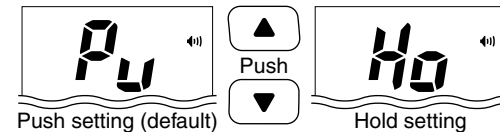

◇ **Backlight function**

“BACKLIGHT”

This function is convenient for nighttime operation. The backlight can be selected from ON and OFF.

- The backlight is automatically activated when any key except for [PTT] is pushed.
- The backlight is automatically turned OFF after 5 sec. of inactivity.

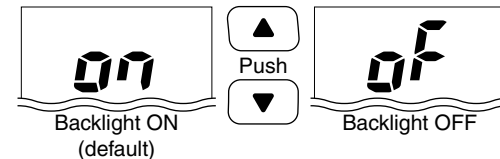

## 7 SET MODE

### ◇ LCD contrast selection “CONTRAST”

The contrast of the LCD can be selected from Hi (default) and Lo.

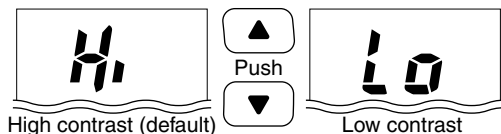

### ◇ Auto power save function “POWER SAVE”

The auto power save function reduces current drain by deactivating the receiver circuit for preset intervals.

- ON : The power save function is turned ON. The power save function will activate when no signal is received, and no operation is performed for 5 sec.
- OFF : The power save function is turned OFF.

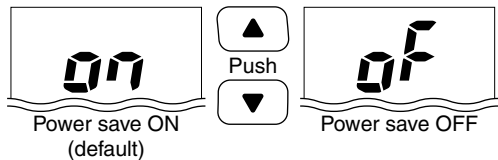

### ◇ Self check function “SELF CHECK”

The self check function informs you in case a problem is found with the radio. Self check automatically and quickly runs through its diagnostic steps each time the radio is turned ON. Afterwards, the radio switches to normal operation mode.

- Temperature : Outside of  $-35^{\circ}\text{C}$  to  $+73^{\circ}\text{C}$ ;  $-31^{\circ}\text{F}$  to  $+163^{\circ}\text{F}$  (approx.)
- Connected battery voltage
- Water intrusion

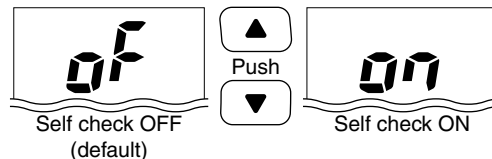

When any of the bellow error messages appear, see the troubleshooting section of this document for advice. (p. 30)

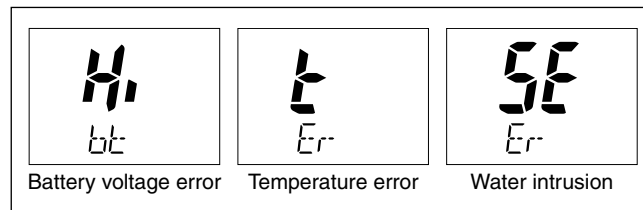

◇ **Battery voltage indicator** “BATT VOLT”

This function controls display or non-display settings of the connected battery pack's voltage when the power is ON.

- The voltage of the connected battery pack is displayed for 2 sec. after power is turned ON.

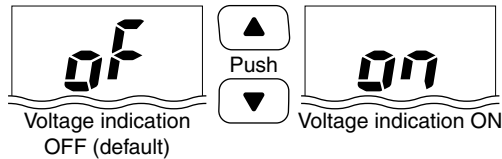

◇ **Squelch sensitivity function** “SQL SENS”

When this function is turned ON (local), blocking against noise is improved and the squelch is not easily affected by noise.

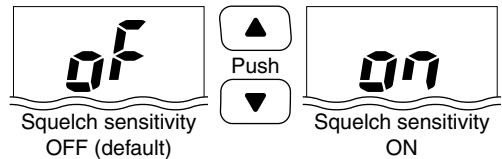

◇ **Channel name scroll type** “SCR TYPE”

Selects the channel name/comment scroll type from 1 and 2.

- 1: The first 7 characters are displayed for 1 sec. (approx.) then scrolls. When the channel name/comment is 7 character or less, it does not scroll (default).
- 2: The channel name/comment scrolls regardless of the number of characters after no name/comment (blank) is indicated for 1 sec.

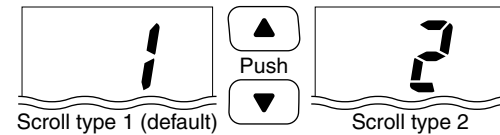

◇ **Scrolling speed** “SCR SPEED”

Selects the channel name/comment scroll speed.

- 1: Scrolls 3.33 characters in a second.
- 2: Scrolls 2.5 characters in a second.
- 3: Scrolls 2 characters in a second.

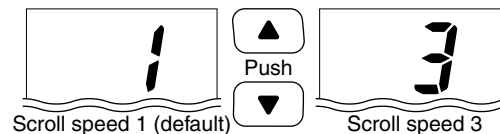

## 7 SET MODE

### ◇ Voice scrambler code “SCRAM CODE”

(available with some versions only)

There are 32 codes (1 to 32) available for programming. In order to understand each other, all transceivers in your group must share the same scrambler code.

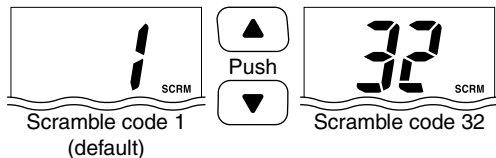

### ◇ VOX gain “VOX GAIN”

Adjusts the VOX gain level from 1 (high sensitivity) to 6 (low sensitivity) when speaking with the optional headset.

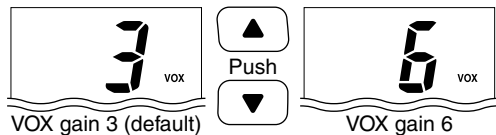

### ◇ VOX delay “VOX DELAY”

Sets the VOX delay timer (0.5 to 3.0 sec. in 0.5 sec. steps) so that the transceiver keeps on transmitting after you stop speaking.

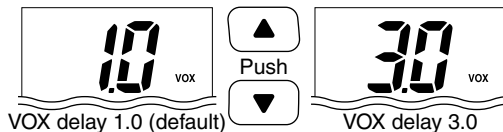

## ■ Battery cautions

Misuse of Lithium-ion batteries may result in the following hazards: smoke, fire, or battery rupture. Misuse can also cause other battery damage or degradation of battery performance.

- **⚠ DANGER!** Use and charge only specified Icom battery pack with Icom transceiver. Only Icom battery pack is tested and approved for use with Icom transceiver. Using third-party or counterfeit battery packs may cause smoke, fire, or cause the battery to burst.

### ◇ Battery caution

- **⚠ DANGER! DO NOT** hammer or otherwise impact the battery. Do not use the battery if it has been severely impacted or dropped, or if the battery has been subjected to heavy pressure. Battery damage may not be visible on the outside of the case. Even if the surface of the battery does not show cracks or any other damage, the cells inside the battery may rupture or catch fire.
- **⚠ DANGER! NEVER** use or leave battery pack in areas with temperatures above +60°C (+140°F). High temperature buildup in the battery, such as could occur near fires or stoves, inside a sun-heated car, or by setting the battery in direct sunlight may cause the battery to rupture or catch fire. Excessive temperatures may also degrade battery performance or shorten battery life.

- **⚠ DANGER! DO NOT** expose the battery to rain, snow, seawater, or any other liquids. Do not charge or use a wet battery. If the battery gets wet, be sure to wipe it dry before using. The battery by itself is not waterproof.
- **⚠ DANGER! NEVER** incinerate a used battery pack since internal battery gas may cause a rupture or explosion.
- **⚠ DANGER! NEVER** solder the battery terminals, or **NEVER** modify the battery pack. This may cause heat generation, and the battery may rupture, emit smoke or catch fire.
- **⚠ DANGER!** Use the battery only with the transceiver for which it is specified. Never use a battery with any other equipment, or for any purpose that is not specified in this instruction manual.
- **⚠ DANGER!** If fluid from inside the battery gets in your eyes, blindness can result. Rinse your eyes with clean water, without rubbing them, and see a doctor immediately.
- **WARNING!** Immediately stop using the battery if it emits an abnormal odor, heats up, or is discolored or deformed. If any of these conditions occur, contact your Icom dealer or distributor.
- **WARNING!** Immediately wash, using clean water, any part of the body that comes into contact with fluid from inside the battery.

## 8 BATTERY CHARGING

- **WARNING! NEVER** put the battery in a microwave oven, high-pressure container, or in an induction heating cooker. This could cause overheating, a fire, or cause the battery to rupture.
- **CAUTION!** Always use the battery within the specified temperature range for the transceiver (–20°C to +60°C; –4°F to +140°F) and the battery itself (–20°C to +60°C; –4°F to +140°F). Using the battery out of its specified temperature range will reduce the battery's performance and battery life. Please note that the specified temperature range of the battery may exceed that of the transceiver. In such cases, the transceiver may not work properly because it is out of its operating temperature range.
- **CAUTION!** Shorter battery life could occur if the battery is left fully charged, completely discharged, or in an excessive temperature environment (above +45°C; +113°F) for an extended period of time. If the battery must be left unused for a long time, it must be detached from the radio after discharging. You may use the battery until the remaining capacity is about half, then keep it safely in a cool dry place with the temperature range as below;
  - 20°C to +50°C (–4°F to +122°F) (within a month)
  - 20°C to +35°C (–4°F to +95°F) (within three months)
  - 20°C to +20°C (–4°F to +68°F) (within a year)

### ◇ Charging caution

- **⚠ DANGER! NEVER** charge the battery pack in areas with extremely high temperatures, such as near fires or stoves, inside a sun-heated car, or in direct sunlight. In such environments, the safety/protection circuit in the battery will activate, causing the battery to stop charging.
- **WARNING! DO NOT** charge or leave the battery in the battery charger beyond the specified time for charging. If the battery is not completely charged by the specified time, stop charging and remove the battery from the battery charger. Continuing to charge the battery beyond the specified time limit may cause a fire, overheating, or the battery may rupture.
- **WARNING! NEVER** insert the battery and transceiver (battery attached to the transceiver) into the charger if it is wet or soiled. This could corrode the battery charger terminals or damage the charger. The charger is not waterproof.
- **CAUTION! DO NOT** charge the battery outside of the specified temperature range: ±0°C to +45°C (+32°F to +113°F). Icom recommends charging the battery at +20°C (+68°F). The battery may heat up or rupture if charged out of the specified temperature range. Additionally, battery performance or battery life may be reduced.

## ■ Supplied battery charger

### ◇ BC-166 installation

- To a desktop
- Supplied screws

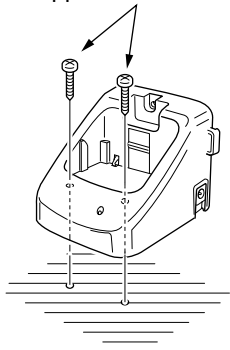

- To a wall
- Supplied screws

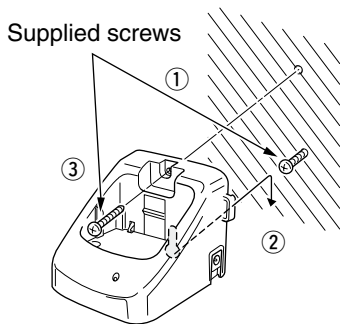

- For added stability

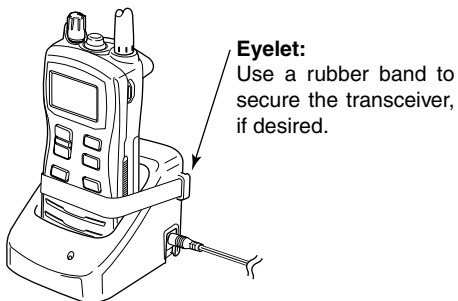

### ◇ Charging

- ① Connect the AC adapter as shown below.
- ② Insert the battery pack with/without the transceiver into the charger.
  - The charge indicator lights orange.
- ③ Charge the battery pack approx. 11 hours, depending on the remaining power condition.
  - The charge indicator lights green when charging is complete.

**NOTE:** The battery charger, BC-166, has charging timer. The timer stops the charging process after 14 hours (approx.).

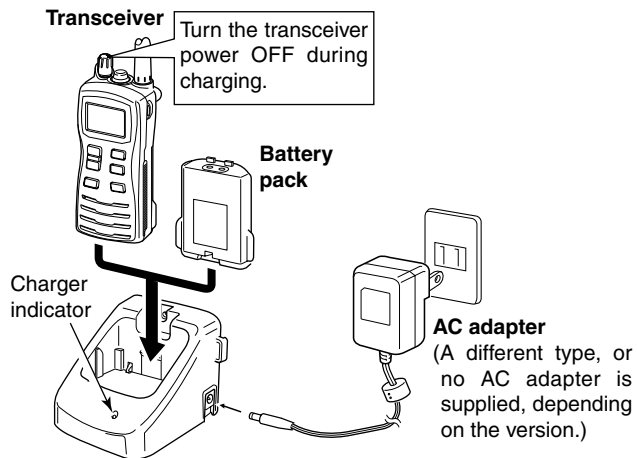

### ■ Optional battery chargers

#### ◇ AD-114 installation

- ① Connect both the 3-pin and 10-pin connectors of the charger to the AD-114 desktop charger adapter's plug.
- ② Install the adapter into the charger in the direction of the arrow, then use the supplied 2 screws to secure the charger adapter to the charger.

Desktop charger adapter

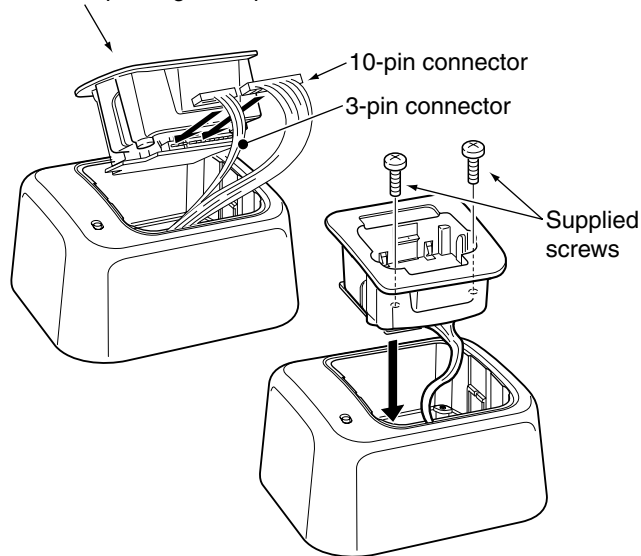

#### ◇ Rapid charging with the BC-119N+AD-114

The optional BC-119N provides rapid charging of battery packs. The following options are additionally required.

- AD-114 charger adapter
- An AC adapter (BC-145) or the DC power cable (OPC-515L/CP-17L).

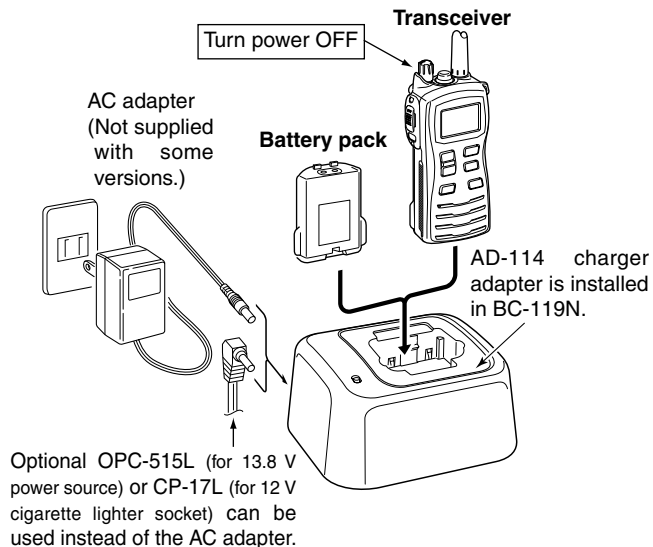



### ◇ Rapid charging with the BC-121N+AD-114

The optional BC-121N allows up to 6 battery packs to be charged simultaneously. The following options are additionally required.

- Six AD-114 charger adapters
- An AC adapter (BC-157) or the DC power cable (OPC-656)

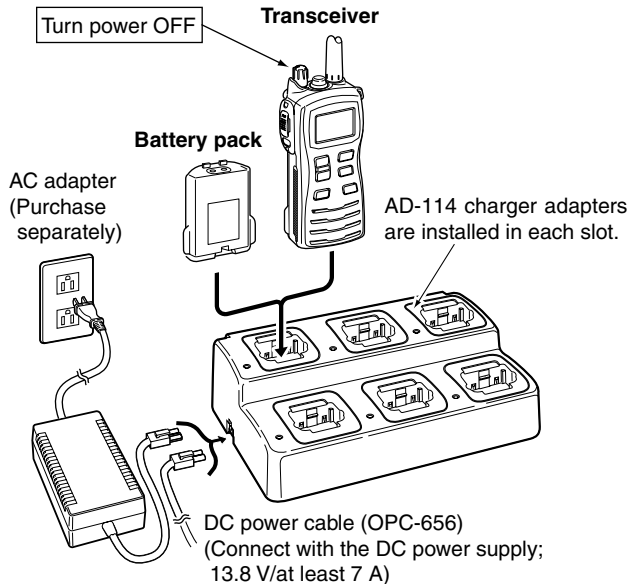

## ■ Attachment

- ① Screw the base clip to the back of the transceiver using the two screws (supplied), as shown at right.

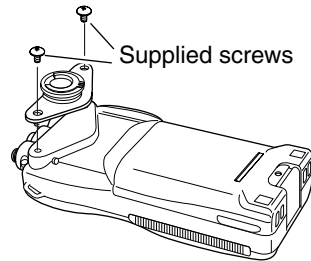

- ② Clip the belt clip over your belt and insert the transceiver.

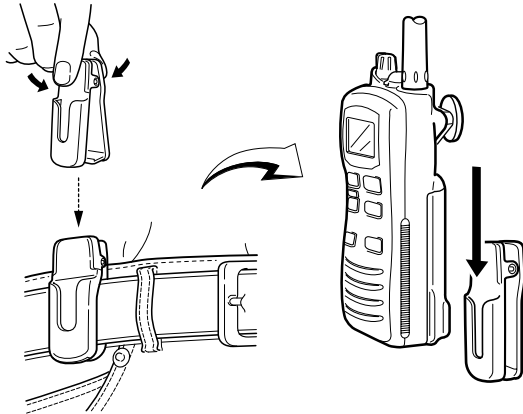

- ③ Once the transceiver is locked in place, it swivels.

## ■ Detachment

- ➔ Turn the transceiver upside down in the direction of the arrow and pull out from the belt clip.

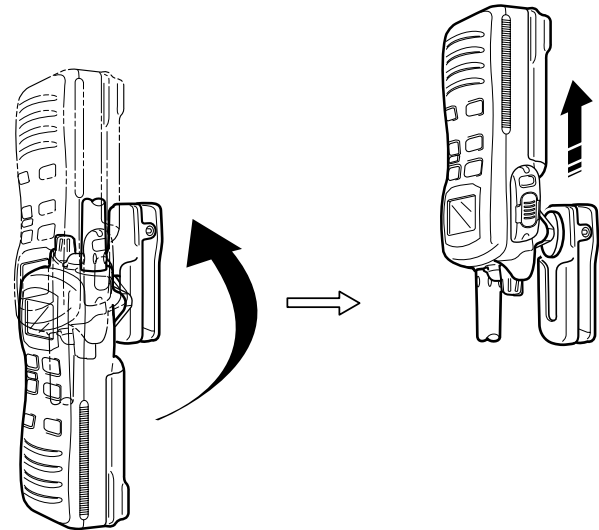

**⚠ CAUTION: HOLD THE TRANSCEIVER TIGHTLY WHEN HANGING OR DETACHING THE TRANSCEIVER FROM THE BELT CLIP.**

Otherwise the transceiver may not be attached to the belt clip or swivelled properly if the transceiver is accidentally dropped and the base clip is scratched or damaged.

## ■ HM-125 descriptions

### Alligator type clip

To attach the speaker-mic. to your shirt or collar, etc.

### PTT switch

Transmits during push.  
Receives during release.

### Microphone

### Speaker

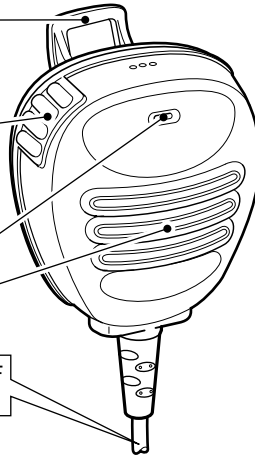

Turn the transceiver power OFF when connecting the HM-125.

**NEVER** immerse the connector in water. If the connector becomes wet, be sure to dry it **BEFORE** attaching it to the transceiver.

**NOTE:** The microphone is located at the top of the speaker-microphone, as shown in the diagram above. To maximize the readability of your transmitted signal (voice), hold the microphone approx. 2.5 cm (1 inch) from your mouth, and speak in a normal voice level.

## ■ Attachment

Insert the speaker-mic connector onto the [SP MIC] connector and carefully screw it tight, as shown in the diagram below. Be careful not to cross-thread the connection.

Set the triangle mark to the front side.

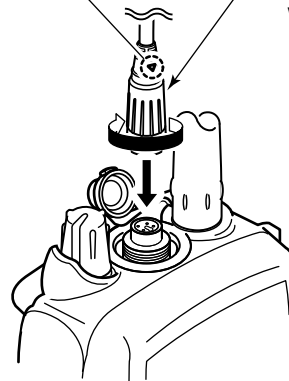

**CAUTION:** Attach the speaker-microphone's connector securely to prevent accidental dropping, or water intrusion in the connector.

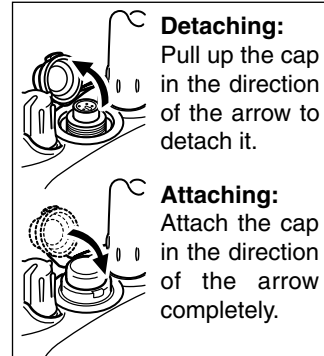

### Detaching:

Pull up the cap in the direction of the arrow to detach it.

### Attaching:

Attach the cap in the direction of the arrow completely.

**IMPORTANT:** **KEEP** the transceiver's [SP MIC] connector cap attached when the speaker-microphone is not in use. Water will not get into the transceiver even if the cover is not attached; however, the terminals (pins) will become rusty, or the transceiver will function abnormally if the connector has become wet.

# 11 TROUBLESHOOTING

PROBLEM	POSSIBLE CAUSE	SOLUTION	REF.
The transceiver does not turn ON.	<ul style="list-style-type: none"> <li>• The battery is depleted.</li> <li>• Bad connection to the battery pack.</li> </ul>	<ul style="list-style-type: none"> <li>• Recharge the battery pack.</li> <li>• Check the connection to the transceiver.</li> </ul>	<p>pgs. 25–27 p. 3</p>
No sound from the speaker.	<ul style="list-style-type: none"> <li>• Squelch level is too tight.</li> <li>• Volume level is too low.</li> <li>• Speaker has been exposed to water.</li> <li>• Water has entered to [SP MIC] connector.</li> </ul>	<ul style="list-style-type: none"> <li>• Set squelch to the threshold point.</li> <li>• Rotate [VOL] to set a suitable level.</li> <li>• Push and hold both [16•9] and [H/L•LOCK] to drain water from the speaker.</li> <li>• Dry [SP MIC] connector.</li> </ul>	<p>p. 11 p. 9 p. 12 —</p>
Transmitting is impossible, or high power can not be selected.	<ul style="list-style-type: none"> <li>• Some channels are for low power or receive only.</li> <li>• The battery is exhausted.</li> <li>• The battery is overcharged.</li> <li>• The output power is set to low.</li> </ul>	<ul style="list-style-type: none"> <li>• Change channels.</li> <li>• Recharge the battery pack.</li> <li>• Verify the battery voltage is correct.</li> <li>• Push [H/L•LOCK] to select high power.</li> </ul>	<p>pgs. 8, 9, 31 pgs. 25–27 — p. 9</p>
The displayed channel cannot be changed.	<ul style="list-style-type: none"> <li>• Lock function is activated.</li> </ul>	<ul style="list-style-type: none"> <li>• Push [H/L•LOCK] for 1 sec. to cancel the function.</li> </ul>	<p>p. 10</p>
Scan does not start.	<ul style="list-style-type: none"> <li>• “TAG” channels are not programmed.</li> </ul>	<ul style="list-style-type: none"> <li>• Set the desired channels as “TAG” channels.</li> </ul>	<p>p. 15</p>
No beeps.	<ul style="list-style-type: none"> <li>• Beep tones are turned OFF.</li> </ul>	<ul style="list-style-type: none"> <li>• Set the beep tones to ON (Fix Beep/User Beep) in the SET mode.</li> </ul>	<p>p. 18</p>
Self check error. (Temperature)	<ul style="list-style-type: none"> <li>• The temperature is outside of –35°C to +73°C; –31°F to +163°F (approx.).</li> </ul>	<ul style="list-style-type: none"> <li>• Leave the transceiver at room temperature for a while. Turn the power ON to check if the internal temperature has returned to normal.</li> </ul>	<p>—</p>
Self check error. (Battery voltage)	<ul style="list-style-type: none"> <li>• The connected battery pack’s voltage is more than 11 V.</li> </ul>	<ul style="list-style-type: none"> <li>• Verify the battery voltage is correct.</li> </ul>	<p>—</p>
Transmitting continuously while not speaking when using VOX function.	<ul style="list-style-type: none"> <li>• Ambient noise is too loud.</li> </ul>	<ul style="list-style-type: none"> <li>• Push [10] and [H/L•LOCK] to deactivate the VOX function.</li> <li>• Set the VOX gain to lower sensitive value.</li> </ul>	<p>p. 12 p. 22</p>
“CHARGE” comment blinks	<ul style="list-style-type: none"> <li>• The connected battery is depleted.</li> </ul>	<ul style="list-style-type: none"> <li>• Recharge the battery pack.</li> </ul>	<p>pgs. 25–27</p>

# VHF MARINE CHANNEL LIST

# 12

Channel number			Frequency (MHz)	
USA	INT	CAN	Transmit	Receive
	01	01	156.050	160.650
01A			156.050	156.050
	02	02	156.100	160.700
	03	03	156.150	160.750
03A			156.150	156.150
	04		156.200	160.800
		04A	156.200	156.200
	05		156.250	160.850
05A		05A	156.250	156.250
06	06	06	156.300	156.300
	07		156.350	160.950
07A		07A	156.350	156.350
08	08	08	156.400	156.400
09	09	09	156.450	156.450
10	10	10	156.500	156.500
11	11	11	156.550	156.550
12	12	12	156.600	156.600
13*	13	13*	156.650	156.650
14	14	14	156.700	156.700
15*	15*	15*	156.750	156.750
16	16	16	156.800	156.800
17*	17	17*	156.850	156.850
	18		156.900	161.500
18A		18A	156.900	156.900
	19		156.950	161.550

Channel number			Frequency (MHz)	
USA	INT	CAN	Transmit	Receive
19A		19A	156.950	156.950
20	20	20*	157.000	161.600
20A			157.000	157.000
	21	21	157.050	161.650
21A		21A	157.050	157.050
	22		157.100	161.700
22A		22A	157.100	157.100
	23	23	157.150	161.750
23A			157.150	157.150
24	24	24	157.200	161.800
25	25	25	157.250	161.850
26	26	26	157.300	161.900
27	27	27	157.350	161.950
28	28	28	157.400	162.000
	60	60	156.025	160.625
	61		156.075	160.675
61A		61A	156.075	156.075
	62		156.125	160.725
		62A	156.125	156.125
	63		156.175	160.775
63A			156.175	156.175
	64	64	156.225	160.825
64A		64A	156.225	156.225
	65		156.275	160.875
65A	65A	65A	156.275	156.275

Channel number			Frequency (MHz)	
USA	INT	CAN	Transmit	Receive
	66		156.325	160.925
66A	66A	66A*	156.325	156.325
67*	67	67	156.375	156.375
68	68	68	156.425	156.425
69	69	69	156.475	156.475
70	70	70	Rx only	156.525
71	71	71	156.575	156.575
72	72	72	156.625	156.625
73	73	73	156.675	156.675
74	74	74	156.725	156.725
77*	77	77*	156.875	156.875
	78		156.925	161.525
78A		78A	156.925	156.925
	79		156.975	161.575
79A		79A	156.975	156.975
	80		157.025	161.625
80A		80A	157.025	157.025
	81		157.075	161.675
81A		81A	157.075	157.075
	82		157.125	161.725
82A		82A	157.125	157.125
	83	83	157.175	161.775
83A		83A	157.175	157.175
84	84	84	157.225	161.825
84A			157.225	157.225

Channel number			Frequency (MHz)	
USA	INT	CAN	Transmit	Receive
85	85	85	157.275	161.875
85A			157.275	157.275
86	86	86	157.325	161.925
86A			157.325	157.325
87	87	87	157.375	161.975
87A			157.375	157.375
88	88	88	157.425	162.025
88A			157.425	157.425
		21b	Rx only	161.650
		25b	Rx only	161.850
		28b	Rx only	162.000
		83b	Rx only	161.775
WX channel	Frequency (MHz)			
	Transmit	Receive		
1		RX only	162.550	
2		RX only	162.400	
3		RX only	162.475	
4		RX only	162.425	
5		RX only	162.450	
6		RX only	162.500	
7		RX only	162.525	
8		RX only	161.650	
9		RX only	161.775	
10		RX only	163.275	

\*Low power only. **NOTE:** Simplex channels 3, 21, 23, 61, 64, 81, 82 and 83 **CANNOT** be lawfully used by the general public in USA waters. The programmed channels are differ according to versions.

# 13 SPECIFICATIONS

## ◇ GENERAL

- Frequency coverage : TX 156.025–157.425 MHz  
RX 156.050–163.275 MHz
- Mode : 16K0G3E
- Power supply requirement : Specified Icom's battery pack only
- Current drain (at 7.5 V DC; approx.):
  - TX High (at 6 W) 1.7 A
  - TX Mid. (at 3 W) 1.3 A
  - TX Low (at 1 W) 0.7 A
  - RX Max. audio 400 mA (internal speaker)  
200 mA (external speaker)
- Useable temperature range : –20°C to +60°C; –4°F to +140°F
- Frequency error : ±10 ppm
- Antenna connector : SMA (50 Ω nominal)
- Dimensions : 52.5(W) × 125(H) × 30(D) mm  
(Projections not included) 2<sup>1</sup>/<sub>16</sub>(W) × 4<sup>29</sup>/<sub>32</sub>(H) × 1<sup>3</sup>/<sub>16</sub>(D) inch
- Weight (with BP-245N) : Approx. 280 g (9.9 oz)

## ◇ TRANSMITTER

- Output power (at 7.5 V DC) : 6 W\* (High), 3 W (Middle)  
and 1 W (Low) \*5 W for some versions
- Modulation system : Variable reactance frequency modulation
- Max. frequency deviation : ±5 kHz
- Adjacent channel power : 70 dB
- Spurious emissions : –68 dBc typical

## ◇ RECEIVER

- Receive system : Double-conversion superheterodyne
- Sensitivity (12 dB SINAD) : 0.22 μV typical
- Squelch sensitivity : 0.35 μV typical (at threshold)
- Intermodulation rejection ratio : 70 dB typical
- Spurious response rejection ratio:
  - 70 dB typical
- Adjacent channel selectivity : 70 dB typical
- Audio output power :
  - Internal speaker 0.6 W typical at 10% distortion with an 8 Ω load
  - External speaker 0.35 W typical at 10% distortion with an 8 Ω load

**All stated specifications are subject to change without notice or obligation.**

## ◇ BATTERY CASE AND PACK

- **BP-245N** Li-Ion BATTERY PACK  
The same as supplied with the transceiver.  
Voltage : 7.4 V  
Capacity : 1900 mAh (minimum)/2000 mAh (typical)

## ◇ CHARGERS

- **BC-119N** DESKTOP CHARGER + **AD-114** CHARGER ADAPTER  
+ **BC-145** AC ADAPTER  
For rapid charging of battery packs. An AC adapter is supplied with the charger depending on versions. Charging time: approx. 3 to 4 hours
- **BC-121N** MULTI-CHARGER + **AD-114** CHARGER ADAPTER (6 pcs.)  
+ **BC-157** AC ADAPTER  
For rapid charging of up to 6 battery packs (six AD-114's are required) simultaneously. An AC adapter should be purchased separately. Charging time: approx. 3 to 4 hours.
- **BC-166** DESKTOP CHARGER + **BC-147S** AC ADAPTER  
Used for regular charging of battery pack. The same as supplied with the transceiver. Charging time: approx. 11 to 12 hours

## ◇ BELT CLIPS

- **MB-103** BELT CLIP  
The same as supplied with the transceiver.
- **MB-86** SWIVEL BELT CLIP  
Belt clip for swivel type.

## ◇ DC CABLES

- **CP-17L** CIGARETTE LIGHTER CABLE  
Charges the battery pack through a 12 V cigarette lighter socket. (For BC-119N)
- **OPC-515L/OPC-656** DC POWER CABLES  
Charges the battery pack using 13.8 V power source instead of the AC adapter.  
OPC-515L: For BC-119N  
OPC-656 : For BC-121N

## ◇ OTHER OPTIONS

- **HM-125** SPEAKER-MICROPHONE  
Full sized waterproof (IPX7; 1m/30 min.) speaker-microphone. Includes an alligator clip to attach the speaker mic to your shirt, collar, etc.
- **HS-94/HS-95/HS-97** HEADSET + **OPC-1392** HEADSET ADAPTER  
HS-94: Ear-piece type  
HS-95: Neck-arm type  
HS-97: Throat microphone  
\*These headsets and headset adapter are non-waterproof.
- **FA-S64V** FLEXIBLE ANTENNA  
Same as that supplied with the transceiver.

Icom optional equipment is designed for optimal performance when used with this transceiver. We are not responsible for the transceiver being damaged or any accident caused when using non-Icom optional equipment.

Available or applicable options may differ according to countries. Ask your authorized dealer for details.

**Count on us!**

A-6479D-1EX-⑤a

Printed in Japan

© 2005–2013 Icom Inc.

Printed on recycled paper with soy ink.

**Icom Inc.**

1-1-32 Kamiminami, Hirano-ku, Osaka 547-0003, Japan